

# **NUCLEAR FUSION:**

a worthless dream

or a potential energy source on earth

ITER: the “way” to make it a possibility ?

Robert AYMAR

Universidad Autonoma de Madrid

17 November 2010

# Table of Contents

- *Introduction – Nuclear Fusion*
- *What is controlled nuclear fusion?*
  - *Concepts for development*
  - *Physics mechanisms in toroidal magnetic confinement (Tokamak)*
  - *Limits of plasma confinement: turbulent transport*
  - *Experimental results*
- *Why ITER? Why now?*
  - *Overall strategy from physics studies towards power reactor*
  - *The ITER project: objectives*
  - *ITER design features*
  - *Underpinning R & D*
  - *ITER safety and environmental characteristics*
  - *ITER construction plan*
- *Conclusions*



There is a popular view that fusion energy has been just over the horizon for decades, and that it has failed to deliver.

There is a popular view that fusion energy has been just over the horizon for decades, and that it has failed to deliver.

**This is false!**

There is a popular view that fusion energy has been just over the horizon for decades, and that it has failed to deliver.

**This is false!**

Fusion has always been a long-term project.

We have learned a great deal, scientific progress has been impressive, and the potential for energy generation is real.

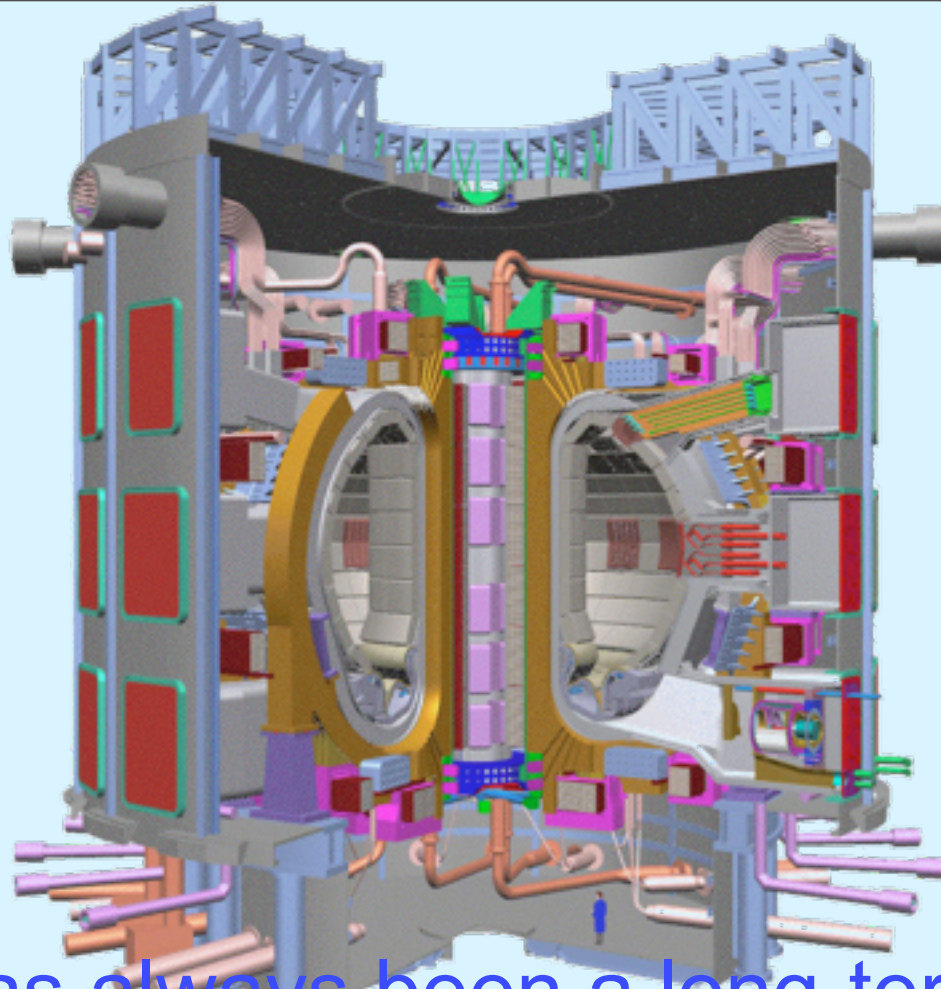

Fusion has always been a long-term project.

We have learned a great deal, scientific progress has been impressive, and the potential for energy generation is real.

# Progress in fusion research

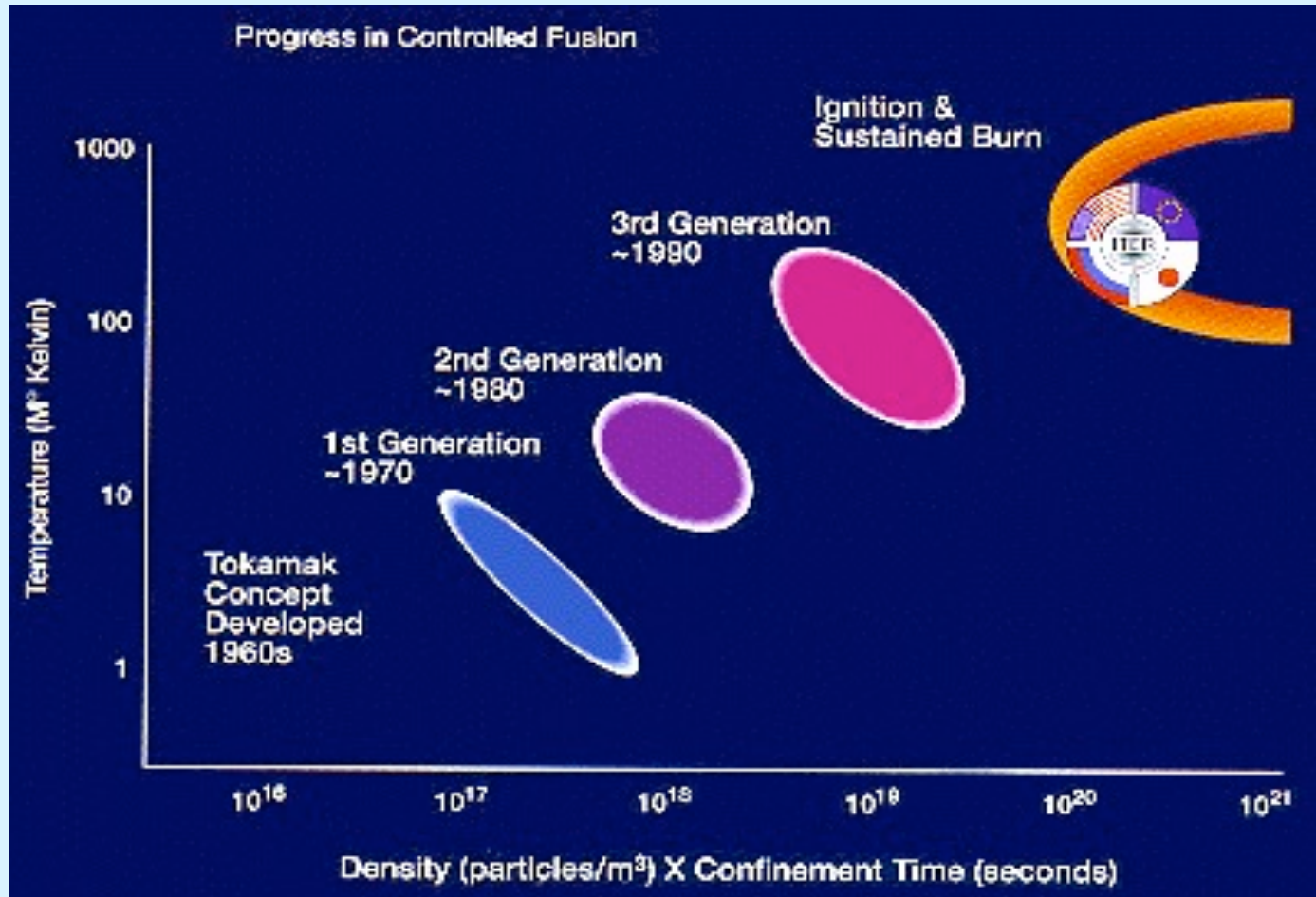



# Past achieved plasma performances

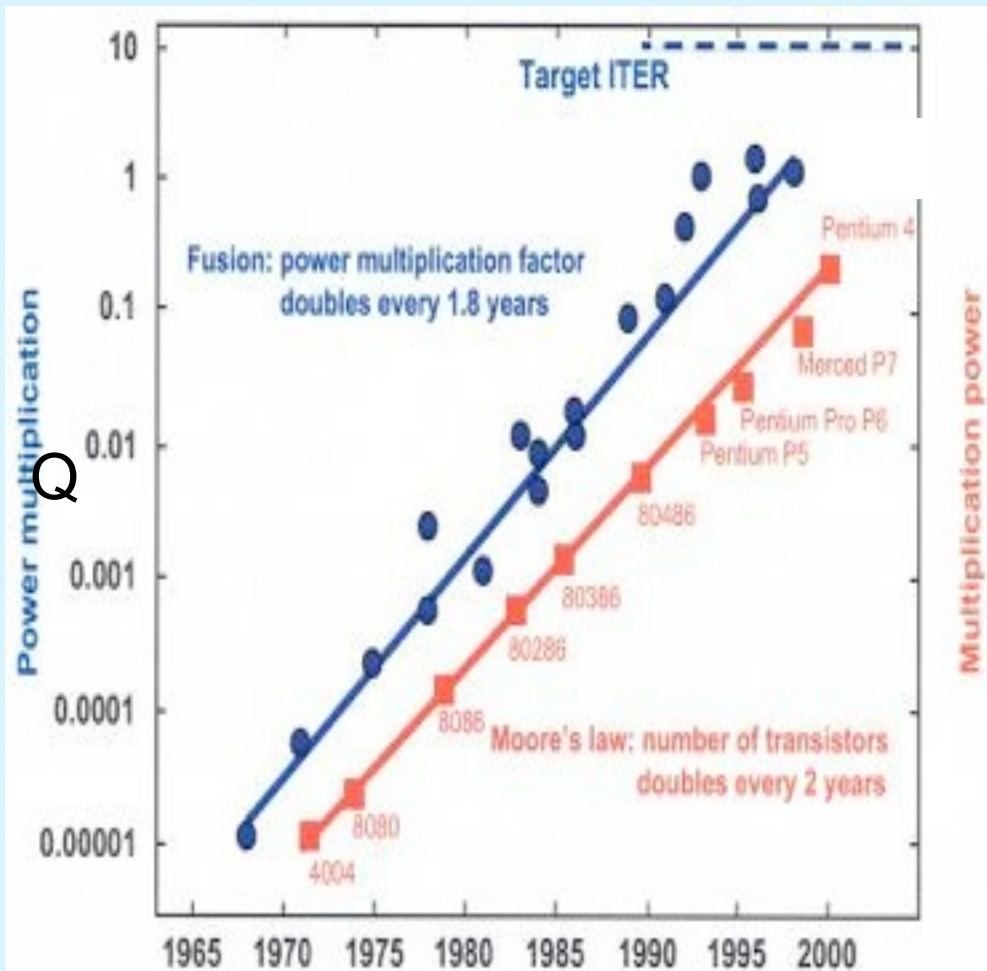

Triple product

$n \tau T$   
[ $10^{20} \text{ m}^{-3} \text{ s keV}$ ]

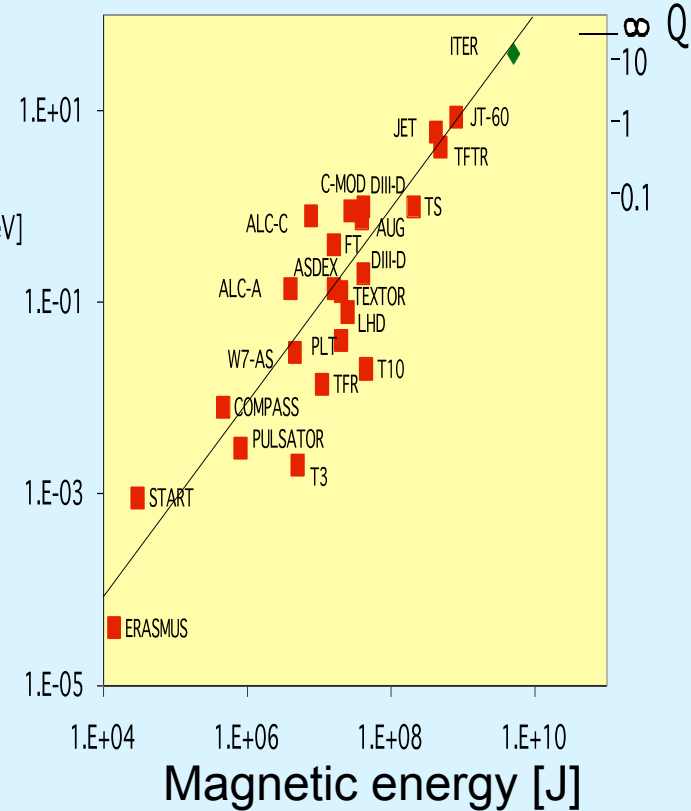

$n\tau T$  and  $Q$  values reached by Tokamak devices versus the magnetic energy<sub>5</sub> stored in their plasma volume.

# The need for new energy sources

**There is a clear correlation between energy consumption and national wealth.**

This will lead to an explosion in demand in developing economies - a phenomenon that is already being seen in China and India.

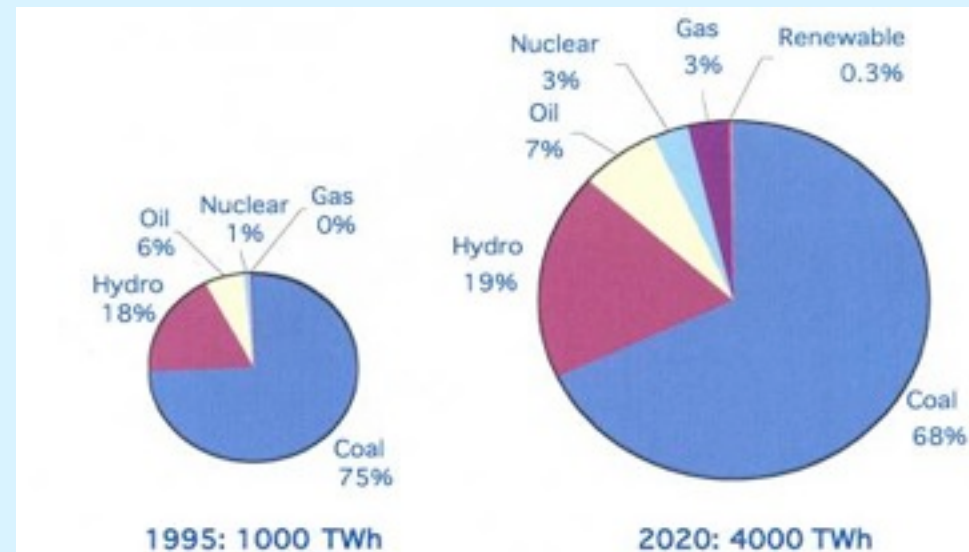
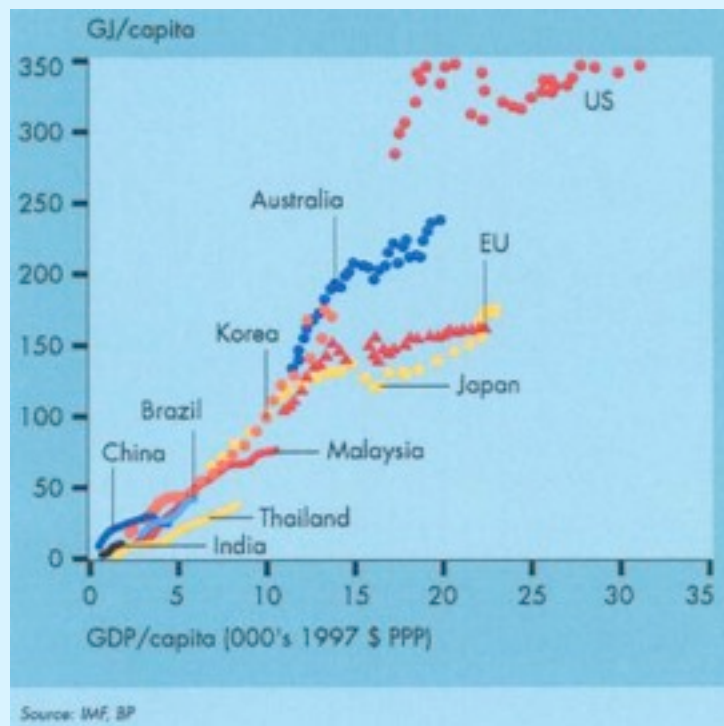

Source: IEA, China's world wide quest for energy, 2000

Today, China generates three quarters of its energy from coal, with hydro accounting for 18%. By 2020, though energy production will have quadrupled. Coal will still be dominant, and

despite high-profile projects such as the Three Gorges dam, hydro will advance by just 1%. **New energy sources with no green-house effect are clearly needed, if we want to stabilize atmospheric concentration of CO2 .**

**New**



Wednesday, November 17, 2010



If the energy supply industry is to satisfy demand, while restricting atmospheric  $\text{CO}_2$ , besides coal-burning plant with total sequestration of the  $\text{CO}_2$  produced, fusion reactors (in concurrence or competition with possible new scheme of nuclear fission) must progressively replace conventional power stations before the end of the century



Wednesday, November 17, 2010



**Fusion has many appealing features:**

**It is environmentally friendly - no greenhouse gases**

**No long-lived radioactive by-products**

**No chance of runaway reactions**

**A very small fuel inventory**

# Table of Contents

- *Introduction – Nuclear Fusion*
- *What is controlled nuclear fusion?*
  - *Concepts for development*
  - *Physics mechanisms in toroidal magnetic confinement (Tokamak)*
  - *Limits of plasma confinement: turbulent transport*
  - *Experimental results*
- *Why ITER? Why now?*
  - *Overall strategy from physics studies towards power reactor*
  - *The ITER project: objectives*
  - *ITER design features*
  - *Underpinning R & D*
  - *ITER safety and environmental characteristics*
  - *ITER construction plan*
- *Conclusions*

# What is Controlled Nuclear Fusion?

- **Nuclear Fusion, besides gravity, is the essential energy source for the universe**
- It is the power source of the stars, which burn lighter elements into heavier ones with the release of energy
  - in the sun, 600 Mt/s of hydrogen combines into helium with a small mass decrease
  - $4 \text{ } ^1\text{H} \rightarrow \text{}^4\text{He} + 2\text{e}^+ + 2 \nu_e + 26.7 \text{ MeV}$  ( $1 \text{ MeV} = 1.6 \cdot 10^{-13} \text{ J}$ )
- For controlled fusion on earth, that process is much too slow; heavier isotopes of hydrogen should be used and the easier process is :



- **Research efforts focus on achieving three conditions**

Two generic implementation concepts are pursued experimentally to achieve those conditions **using two schemes of confinement: magnetic and inertial**, the first more advanced than the second.

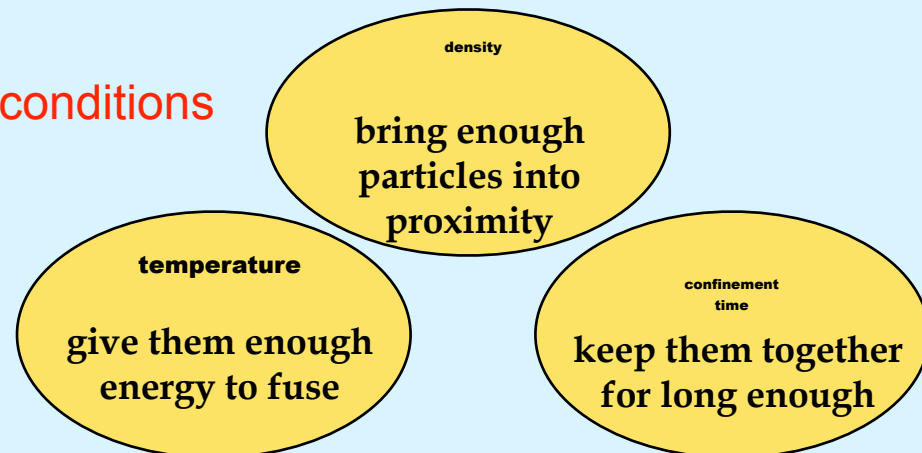



# Concept to develop Nuclear Fusion

## 1. Magnetic confinement for steady state:

- the fuel (D+T) takes the form of a hot plasma inside an appropriate magnetic field configuration in order to limit heat and particle losses
- the process is a nuclear combustion (similar conceptually to a chemical combustion)
- the density is small ( $10^{20}$  p/m<sup>3</sup>) and the pressure  $\sim 1$  bar
  - <sup>4</sup>He produced (20% of the fusion power) remains in the plasma and stabilises the temperature T against power losses
  - <sup>1</sup>n produced (80% of the fusion power) leaves the volume and provides the usable energy, it is slowed down in a cooled "blanket", before being absorbed by the Lithium at low energy and reproducing the tritium. The power balance writes:

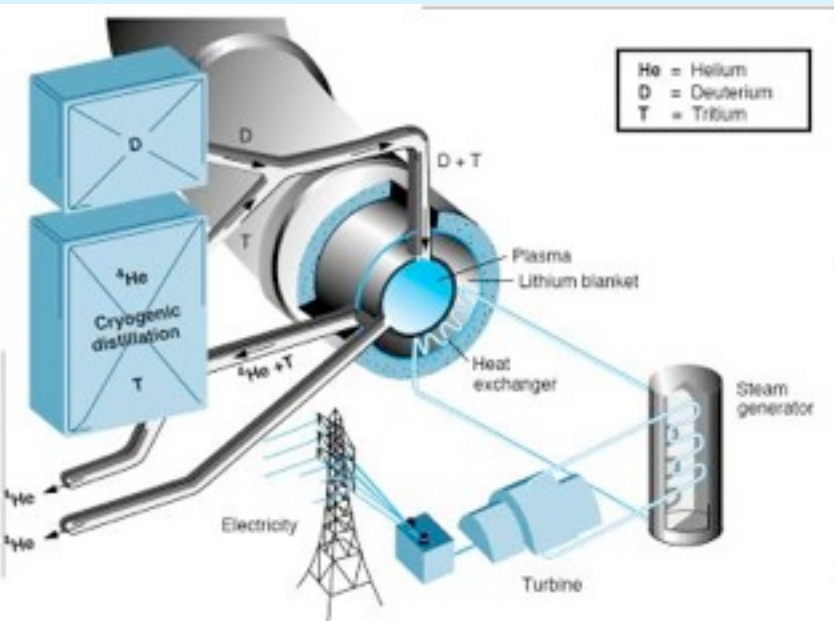

$$\frac{1}{4} n^2 R(T) \frac{E_F}{5} \left( 1 + \frac{5}{Q} \right) \geq \frac{3nT}{\tau_E}$$

fusion power      auxiliary power      power losses

$$n = n_e \quad n_D = n_T = \frac{ne}{2} \quad \text{Plasma density}$$

T temperature

R(T) reaction rate

$$\frac{E_F}{5} = 3.5 \text{ MeV}$$

$$0 < Q = \frac{P_F}{P_{\text{aux}}} < \infty$$

$$n\tau_E T \geq \frac{60T^2}{E_F R(T) \left( 1 + \frac{5}{Q} \right)}$$

$$n\tau_E T \geq \text{minimum for } T \approx 1.5 \times 10^8 \text{ K}$$

# Concept to develop Nuclear Fusion

## 2. Inertial confinement during very short pulses:

- a small pellet of fuel (D+T) is compressed and heated by intense laser or ion beams (direct or indirect drive)
- the density is very high ( $\sim 1000 n_{ice}$ ) and the pressure ( $\sim M$  bars)
- from the hot pellet centre, a burning wave propagates radially supported by the He power; this time the energy balance should be considered with a gain  $G$

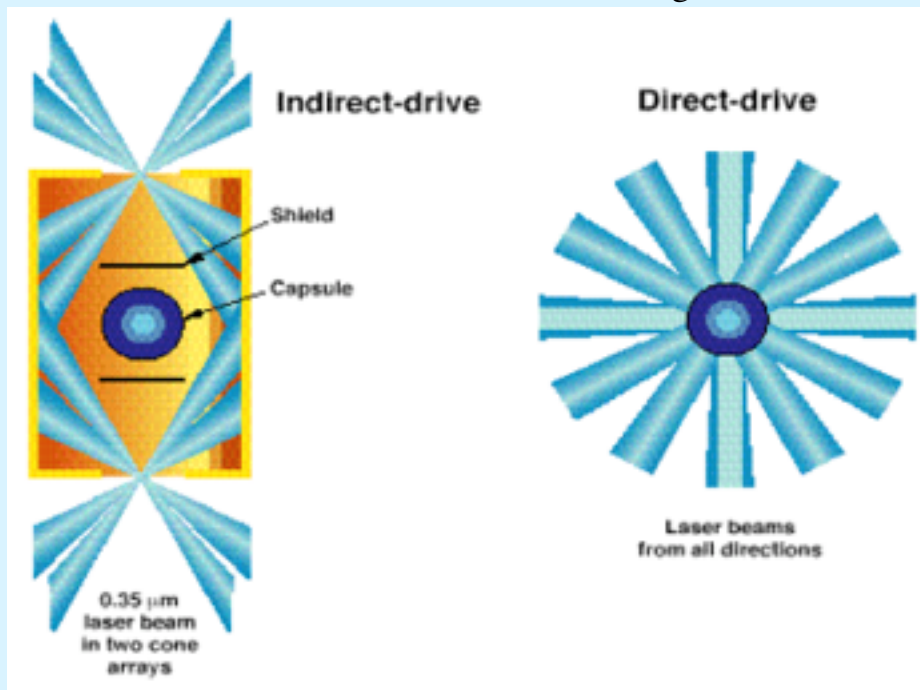

$$G = \frac{E_{\text{Fusion}}}{E_{\text{input}}} \quad \text{large enough } \geq 50 - 100$$

$$n\tau_E T \geq \frac{T}{R(T)} \quad \text{the minimum is obtained for } T \simeq 3 \times 10^8 \text{ K}$$

# Physics mechanisms present in toroidal magnetic confinement (Tokamak) - 1

- **single particles are confined** in the torus, as long as there is a **rotational transformation in the topology of the magnetic lines**: a poloidal magnetic field (due to toroidal plasma current) added to a larger toroidal component
- **The particle motion is periodic** (3 frequencies associated)

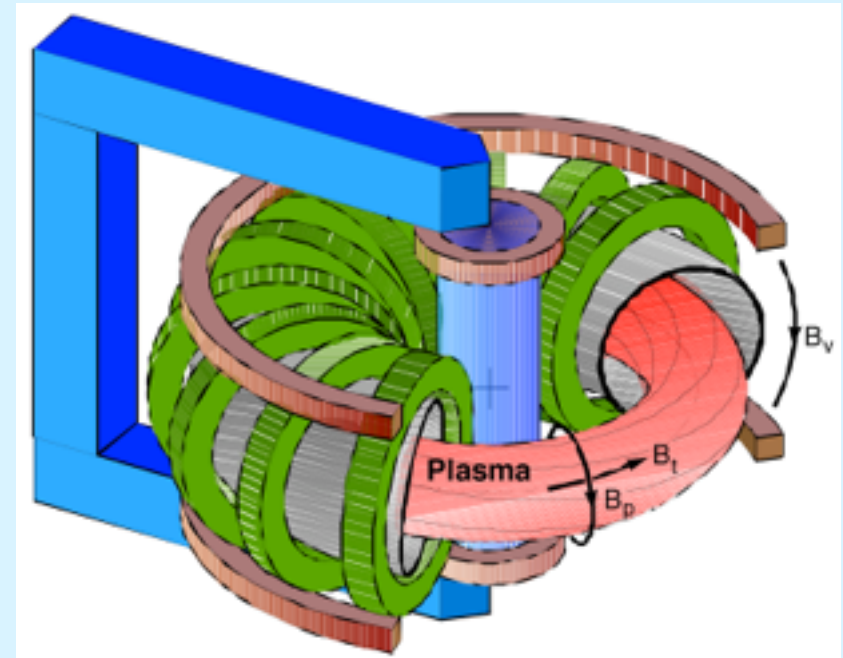
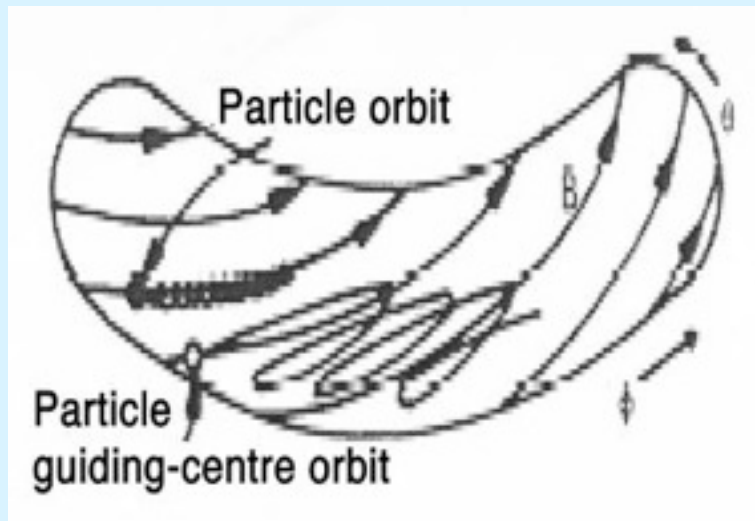

# Physics mechanisms present in toroidal magnetic confinement (Tokamak) - 2

- **magnetic surfaces** are created, nested around a magnetic axis, which are **isobar and isotherm of the plasma**
- across these magnetic surfaces, there are **current density ( $j$ ) and pressure ( $p$ ) profiles providing an equilibrium**
- Open magnetic lines produce a **“divertor”** which allows to localize the plasma contact to the wall, to **control the influx of impurities and insure particles and heat exhaust.**

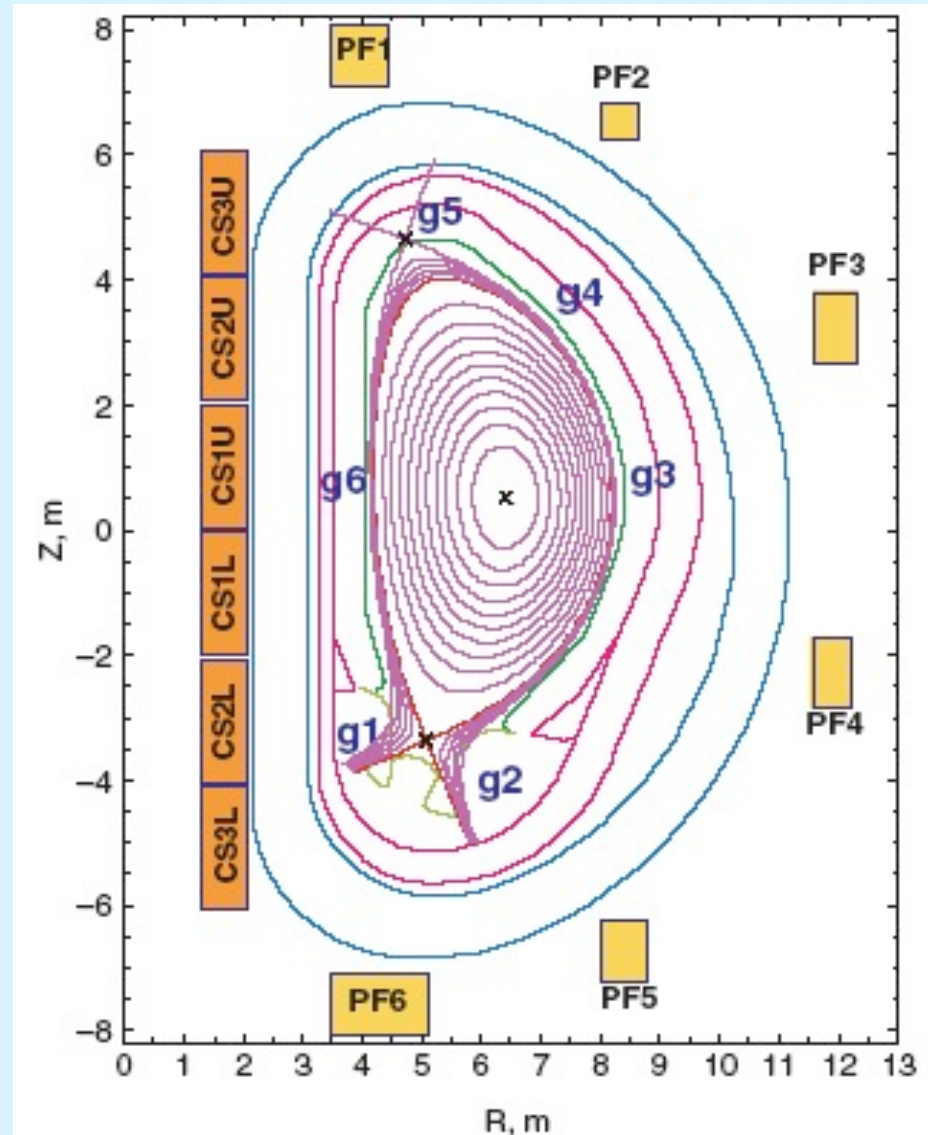

# Limits of plasma confinement

1. **the linear stability of this macroscopic equilibrium controls the operational domain of the tokamak;** the plasma behaves as a fluid, this is magneto hydrodynamics - **two sources of instability:  $\nabla j$  and  $\nabla p$ .**
2. **the non-linear development** of these instabilities depends on the **magnetic shear**, it drives in general **relaxation oscillations and magnetic reconnection**, (not completely understood)

**similar phenomena are at work during solar eruptions,  
in the magnetosphere, in magnetised accretion disks.**

- **Transport phenomena** (particles, heat, momentum across the magnetic surfaces control the plasma losses
  - this is a **turbulent transport due to micro instabilities**, with "vortex cells" of the size of a few ion gyration radii. They are driven by waves, "drift waves" which can be in resonance with the particle motion frequencies and some part of their velocity distribution.
  - again the source of these instabilities is the **pressure gradient of some category of particles** (electrons, ions, high energy ions as He from fusion reaction)
- 1. **All experimental results fit in an empirical scaling law** to deduce the energy confinement from physical parameters ( $B, I, n, \dots$ ); it is in agreement with relation built from non-dimensional parameters (a kind of "wind tunnel" analysis ).
- **These instabilities and associated turbulence are factors limiting the energy confinement:** a **vital issue for the possibility of using Nuclear Fusion as an energy source**

# Limits of plasma confinement = transport barriers

Improvements to the value of  $\tau_E$  come from the existence of generic transport barriers : the transport becomes self limited by the non linear development of the instabilities when the  $\nabla j$  or  $\nabla p$  is forced to larger values, and produces a **shear in magnetic field** (close to the separatrix) or in **velocity**.

## Relations with other physics domains

- Strong analogies with fluid turbulence in particular with the turbulence of a fluid in rotation (atmospheric turbulence)
- In astrophysics, the turbulent viscosity assumed in the models of stellar formation

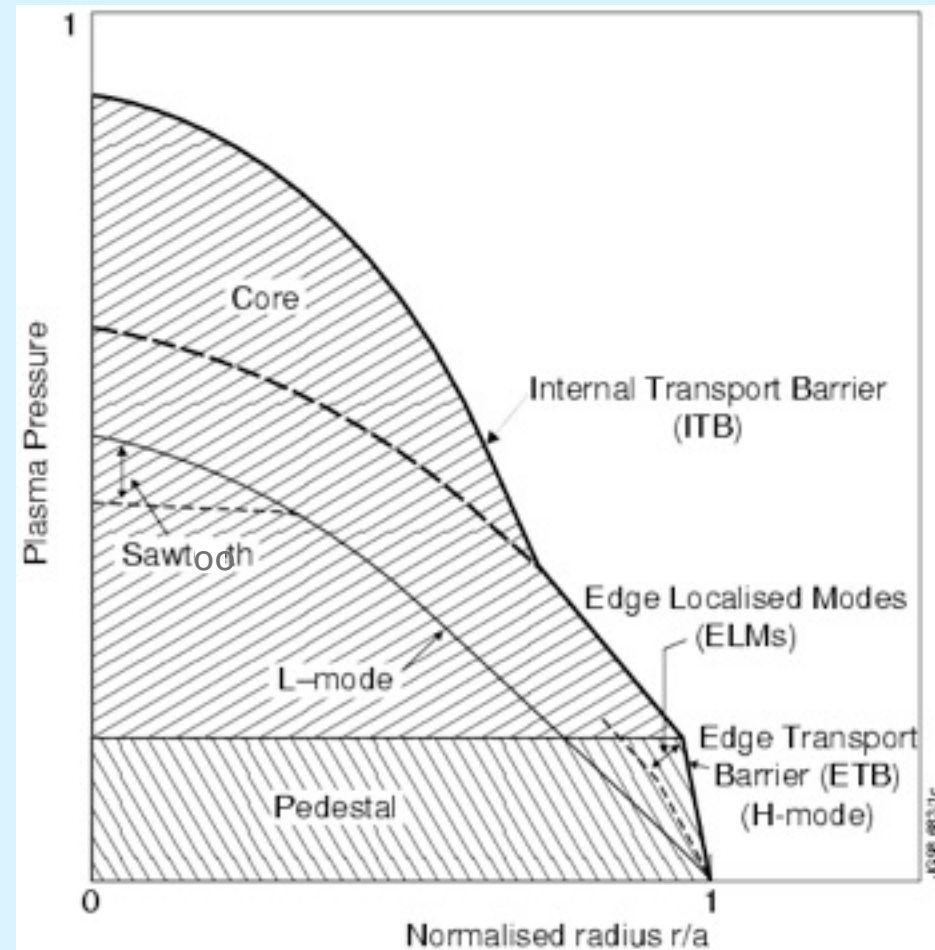

# Experimental results

The results from all experiments running at present show, in particular, the global value of  $\tau_E$ , across more than two orders of magnitude, as function of physical parameters linked by an experimental “scaling law”.

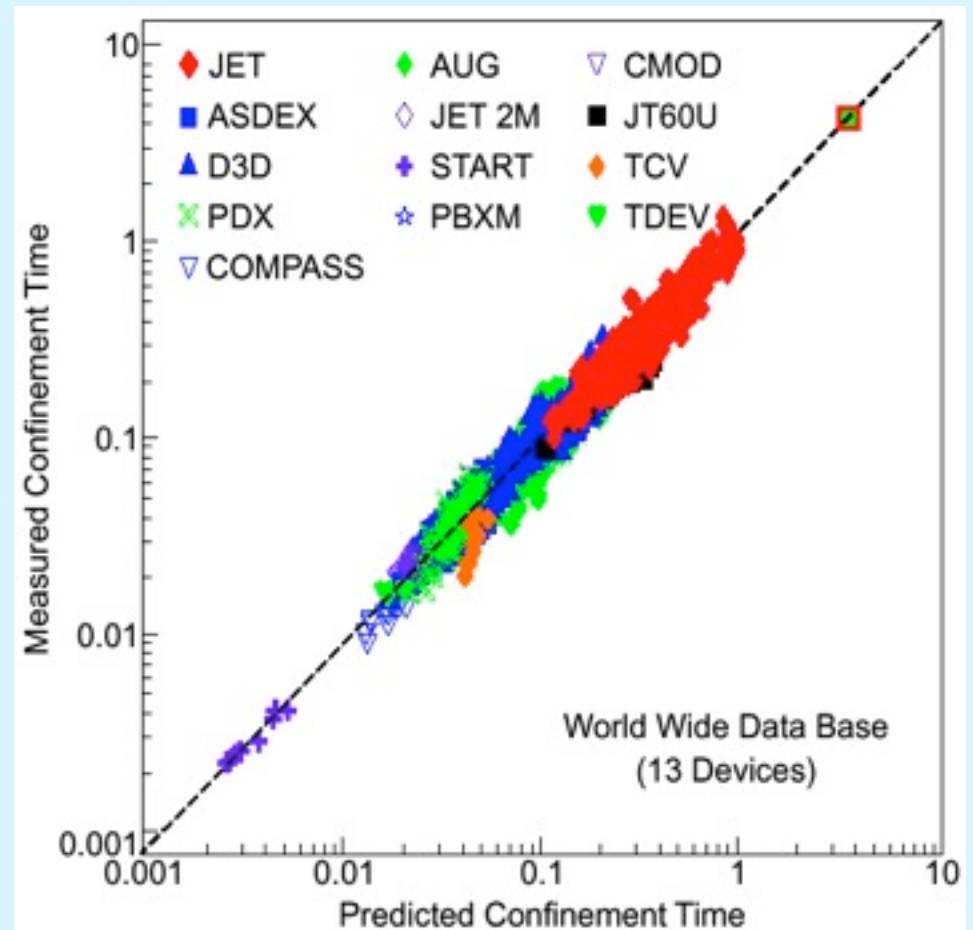
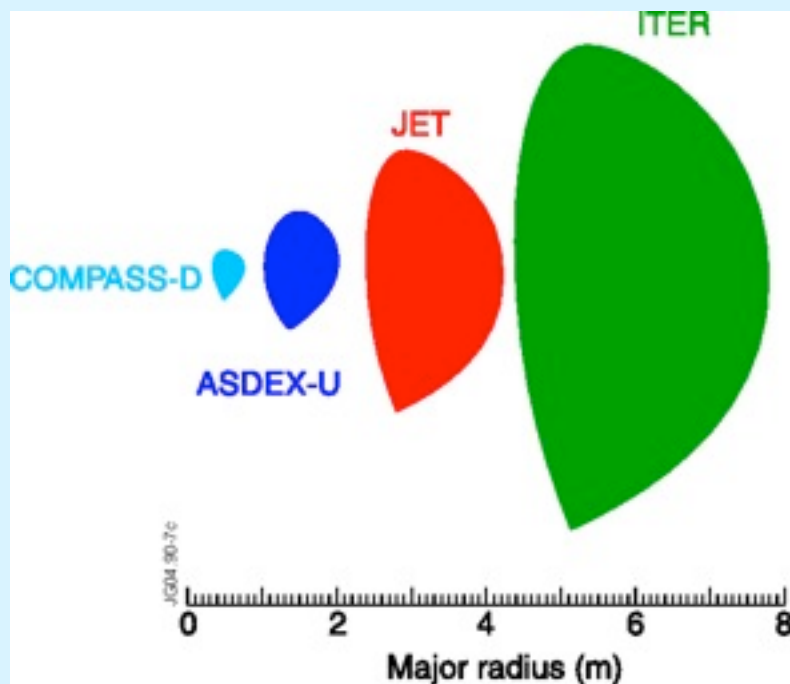

# The Joint European Torus (JET)

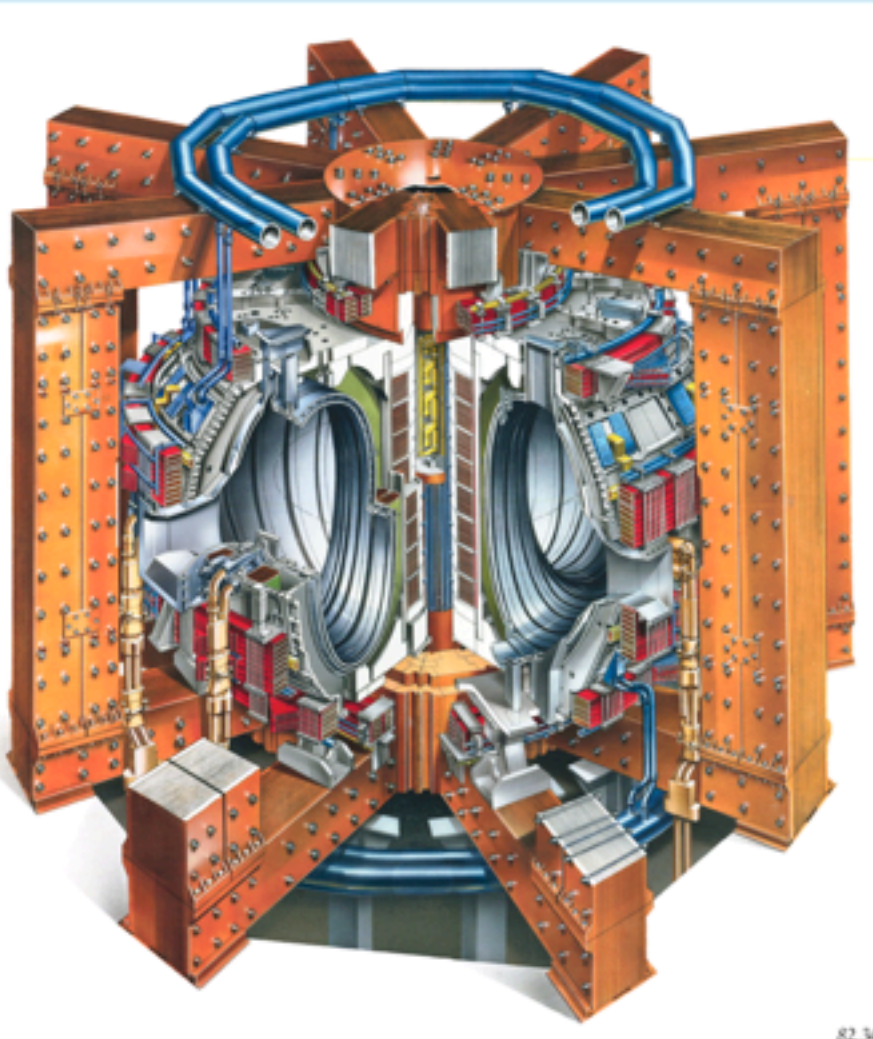

**Plasma operation closest to ITER**

**Torus radius**            3.1 m (*ITER 6m*)

**Vacuum vessel**        3.96m high x 2.4m wide

**Plasma volume**        80 m<sup>3</sup> - 100 m<sup>3</sup>

**Plasma current**        up to 5 MA (*ITER 17MA*)  
in present configurations

**Main confining field**        up to 4 Tesla

**Unique technical capabilities worldwide:**

- Tritium operation
- Beryllium (*ITER First Wall*)
- Remote Handling



# Conditions for the best experimental results

- The largest machines JET (Joint European Torus) and JT60 (Japanese Torus) have achieved the best plasma performances, where  $Q = P_F/P_{aux}$  is close to breakeven.  
**JET has produced 16 MW of D-T fusion power transiently.**
- The successful operation of **the divertor concept** limited the influx of impurities in the plasma and provided the plasma exhaust (particles and thermal energy).
- The development of **powerful plasma heating methods**, by multimegawatt injection of electromagnetic waves or high energy neutrals. Numerous diagnostic methods and measuring instrumentation provided the necessary tools.
- At present, operations of the largest machines, like JET and JT60, are mostly steered to simulate the best conditions for ITER operation in quasi-stationary plasma conditions, with a low level of fluctuations.

# Why ITER?

The present experiments are able to simulate (not necessarily simultaneously) most plasma parameters  $\beta$ ,  $\nu$ ,  $n$ ,  $T$ ,  $j$ ,  $B$  which control the plasma performance, all of them being relevant to a power reactor.

Nevertheless, one effect cannot be experimentally checked, due to the non-linear coupling, inside the plasma volume, between the internal heat source (from He particle, 20% of the fusion power) and the global behavior of the plasma according to its diffusion controlled profiles.

At the world level, only one strategy appeared sensible (more deeply with time) to progress toward the development of an energy source:

- the building of a large enough device according to the present understanding to obtain a burning plasma.
- the validation and optimization of the physics parameters for a possible future electricity generating Demonstration Reactor.
- the development of technologies necessary for this future reactor.

This device, a physics experiment and an experimental reactor, should <sup>20</sup>

# Why ITER? Why now?

Overall Strategy from Physics Studies towards a Power Reactor

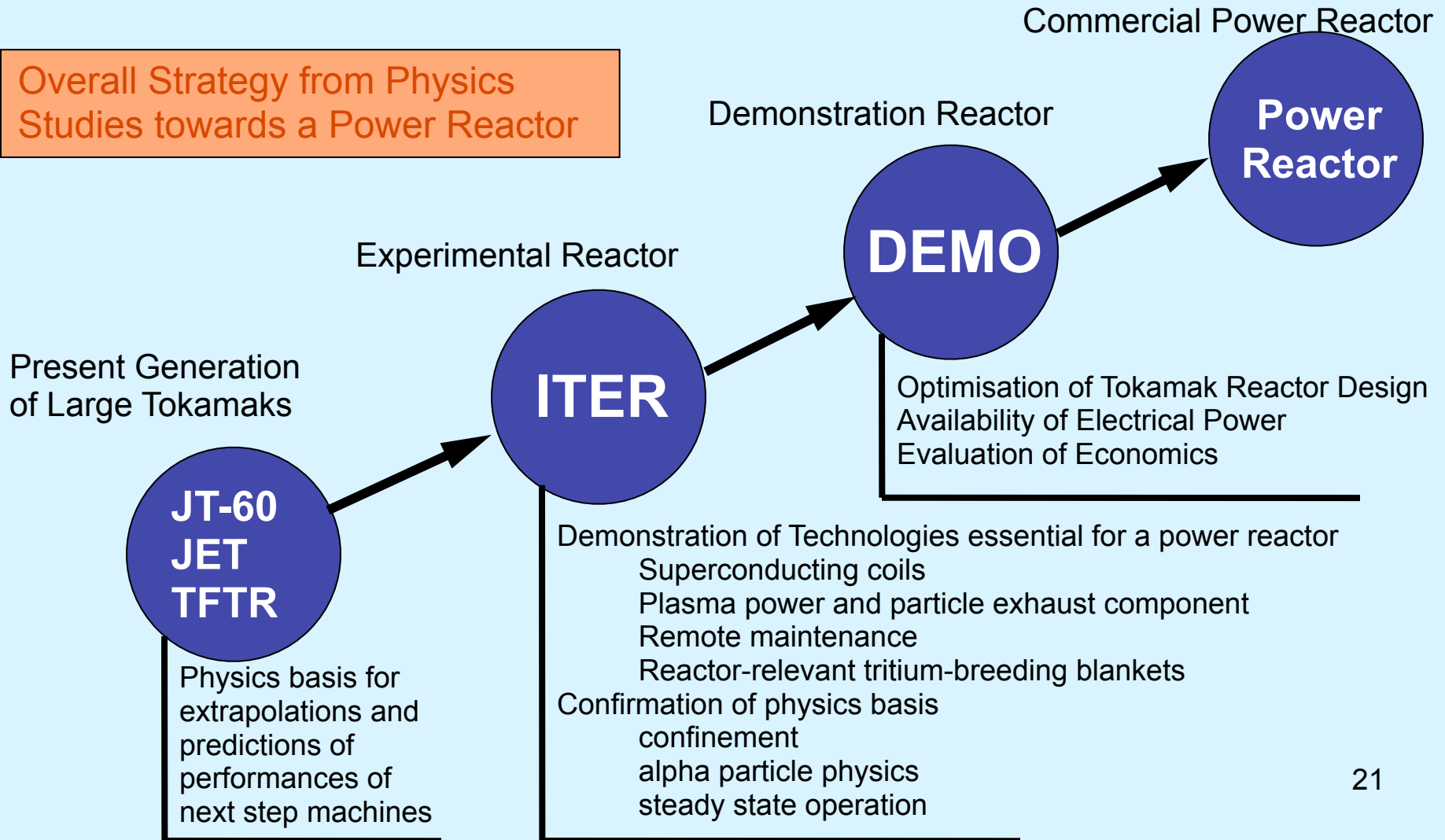

# The ITER project

- initiated in summit discussions: Gorbachev, Reagan, Mitterrand in 1986,
  - **Conceptual Design Activities (1988-90) Engineering Design Activities (EDA)**  
under Inter-governmental Agreement 1992-2001 - IAEA auspices
    - four equal founding Parties (EU,JA,RF,USA) for initial term of Agreement to 1998; then three Parties (EU, JA, RF) for extension period to July 2001
    - design work shared between a distributed Joint Central Team and four “Home” Teams; supporting R&D by Home Teams
    - full output available to each Party to use alone or in collaboration
  - **July 2001** - a “detailed, complete and fully integrated design of ITER and all technical data necessary for future decisions on the construction” are documented
- Negotiations** started between parties, joined by USA , China, India, Korea
- These results were achieved at the expenditure of \$ 660 M (1989 values) on R&D and 1950 professional person years of effort.

# ITER Objectives

## Programmatic

- Scientific and technological feasibility of fusion energy for peaceful purposes.

## Technical

- Moderate Q, extended DT burning plasma, steady state ultimate goal.
- Reactor-essential technologies in system integrating appropriate physics and technology.
- Test high-heat-flux and nuclear components.
- Demonstrate safety and environmental acceptability of fusion.

## Strategic

- Single device answering, in an integrated way, all feasibility issues needed to define a subsequent demonstration fusion power plant (DEMO) except for material developments to provide low activation and larger 14 MeV neutron resistance for in-vessel components

Device with  $Q \geq 10$  and inductive burn of  $\geq 300$  s, aiming at steady state operation with  $Q \geq 5$ , with average neutron wall load  $\geq 0.5$  MW/m<sup>2</sup> and average lifetime fluence of  $\geq 0.3$  MWa/m<sup>2</sup>.

# ITER Nominal Parameters

## Total fusion power

500 MW (700MW)

$Q = \text{fusion power/auxiliary heating power}$

$\geq 10$  (inductive)

Average neutron wall loading

0.57 MW/m<sup>2</sup> (0.8 MW/m<sup>2</sup>)

Plasma inductive burn time

$\geq 300$  s

Plasma major radius

6.2 m

Plasma minor radius

2.0 m

## Plasma current (inductive, $I_p$ )

15 MA (17.4 MA)

Vertical elongation @95% flux surface/separatrix

1.70/1.85

Triangularity @95% flux surface/separatrix

0.33/0.49

Safety factor @95% flux surface

3.0

## Toroidal field @ 6.2 m radius

5.3 T

Plasma volume

837 m<sup>3</sup>

Plasma surface

678 m<sup>2</sup>

# ITER Inductive Performance

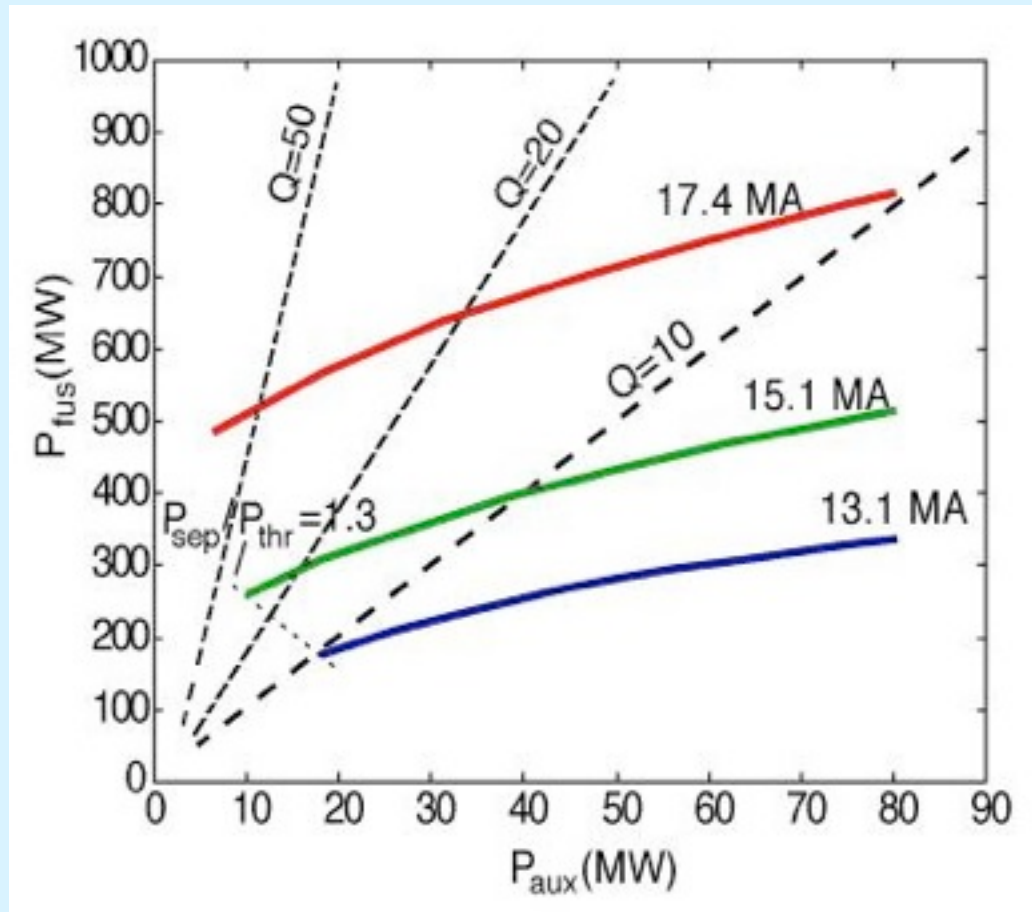

$$H_H = 1$$

$$n_e/n_G = 0.85$$

# ITER Design - Main Features

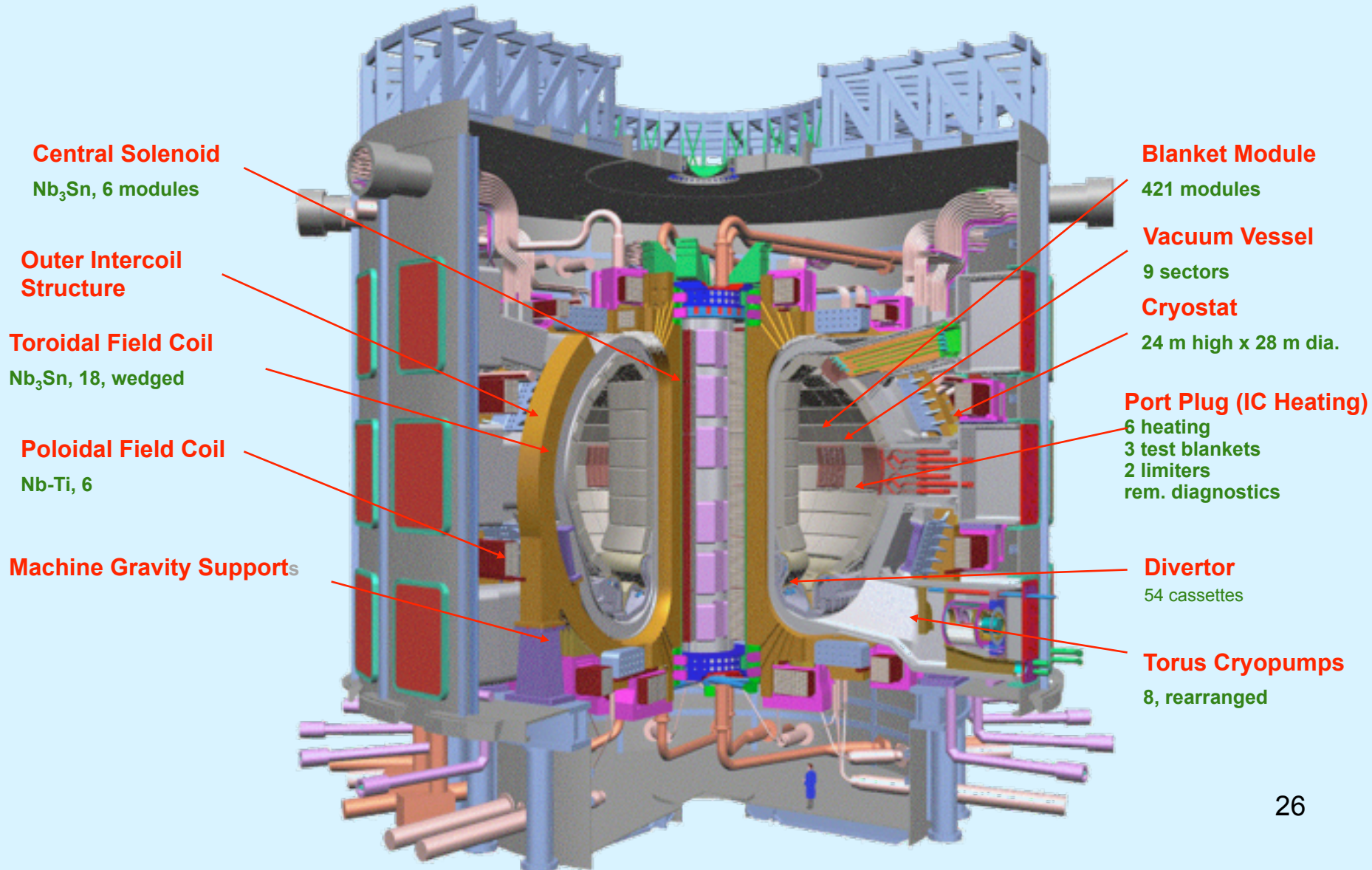



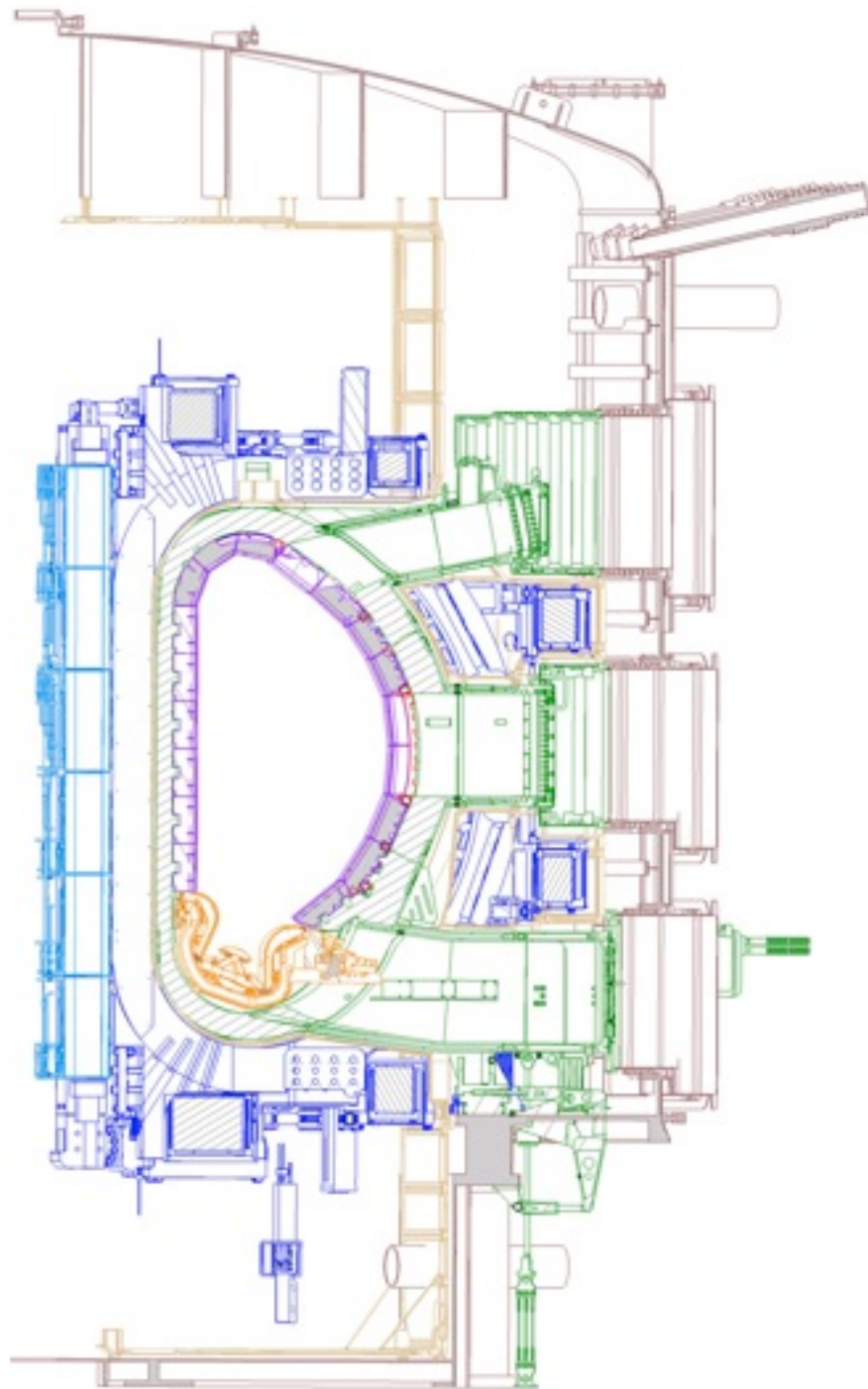

## ITER Cross- section

# ITER Building

- Provides a biological shield around cryostat to minimise activation and permit human access.
- Additional confinement barrier against Tritium leak.
- Allows (with HVAC) contamination spread to be controlled.
- Provides shielding during remote handling cask transport.
- Can be seismically isolated.

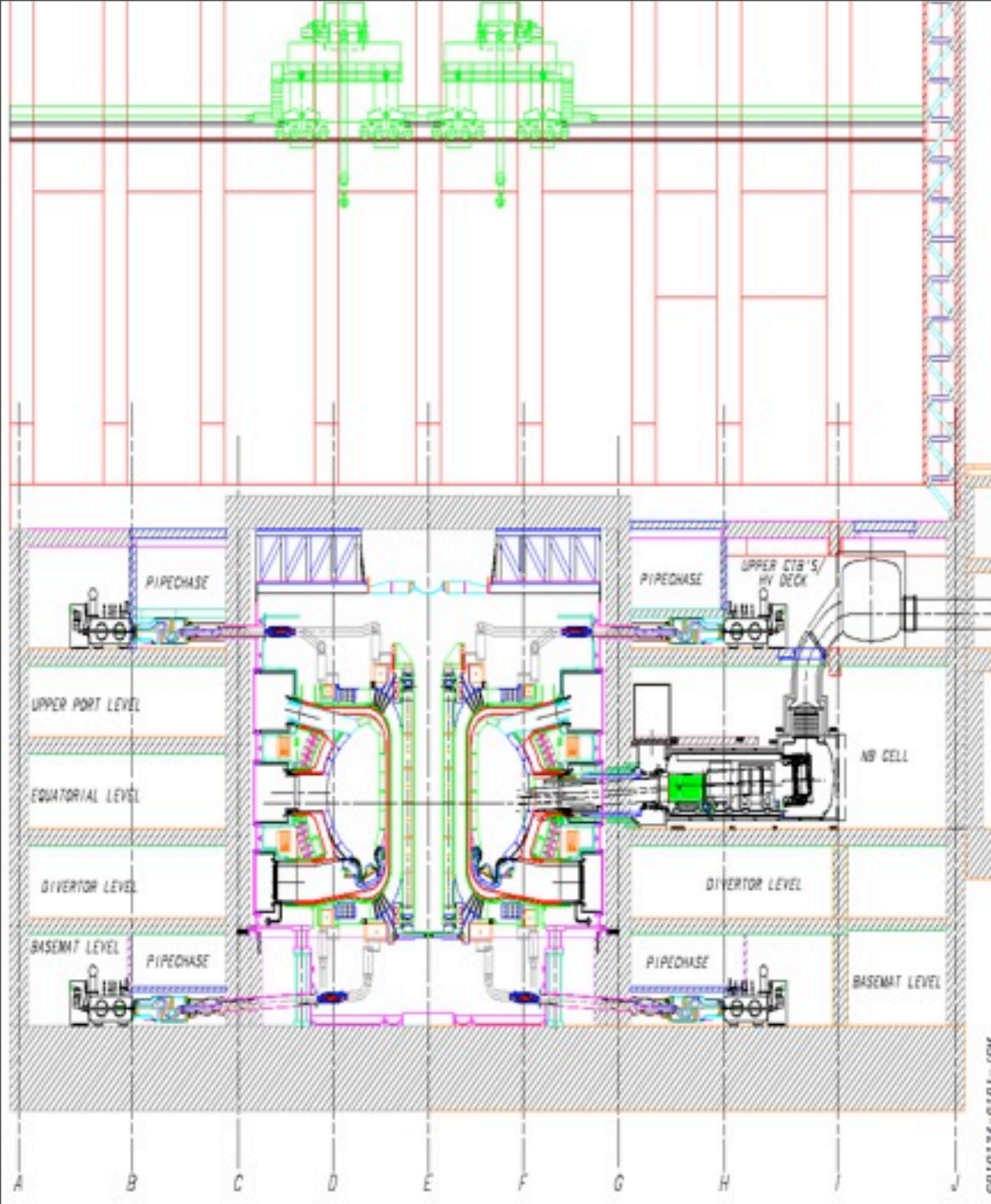

# Magnets and Structures

Superconducting. 4 main subsystems:

- 18  $\text{Nb}_3\text{Sn}$  toroidal field (TF) coils produce confining/stabilizing toroidal field;
- 6  $\text{NbTi}$  poloidal field (PF) coils position and shape plasma;
- 6 modular  $\text{Nb}_3\text{Sn}$  central solenoid (CS) coil induces current in the plasma.
- a set of correction coils (CC) correct error fields due to manufacturing/assembly imperfections and stabilize the plasma against resistive wall

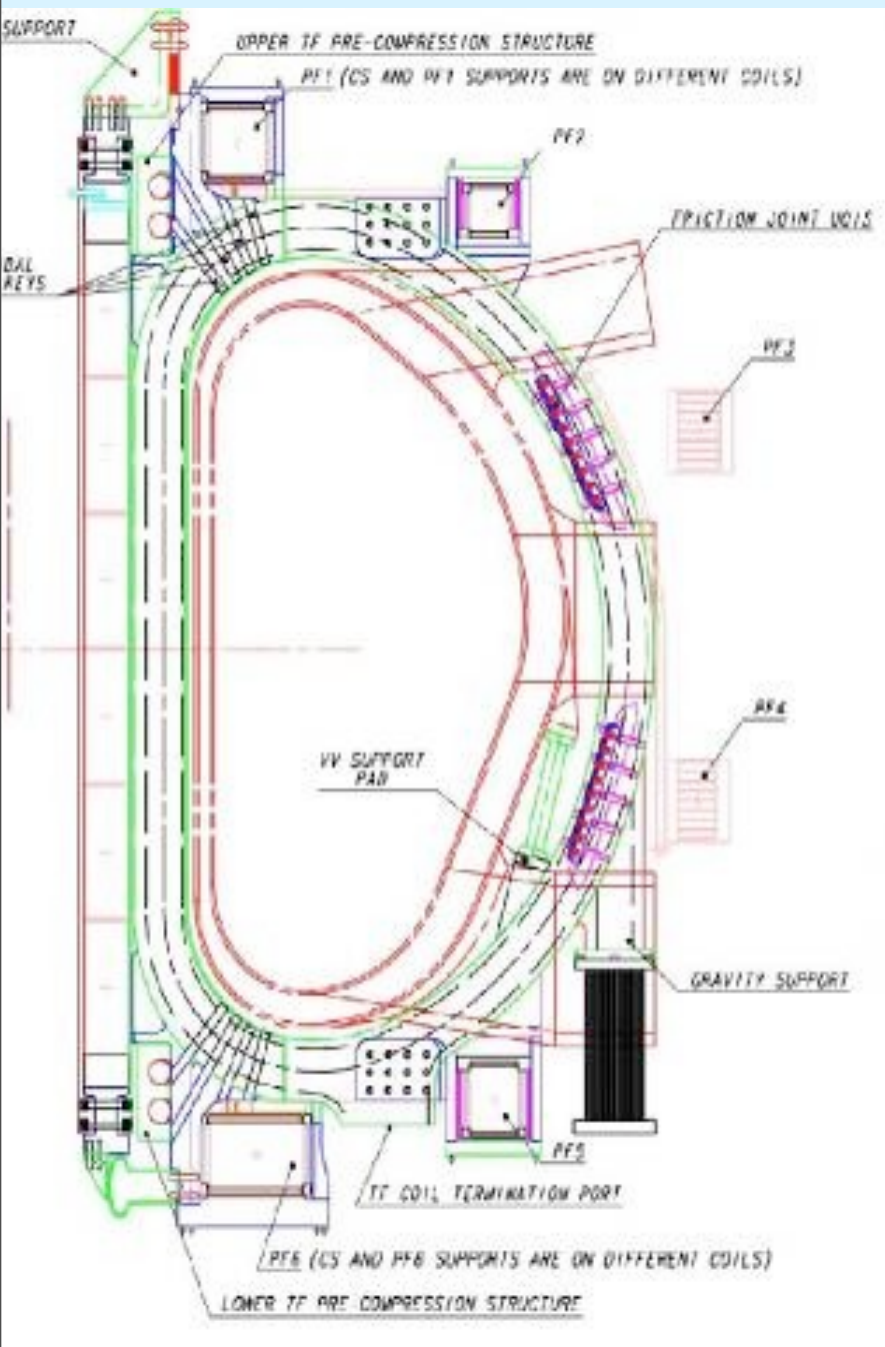

# Design - Vessel, Blanket & Divertor

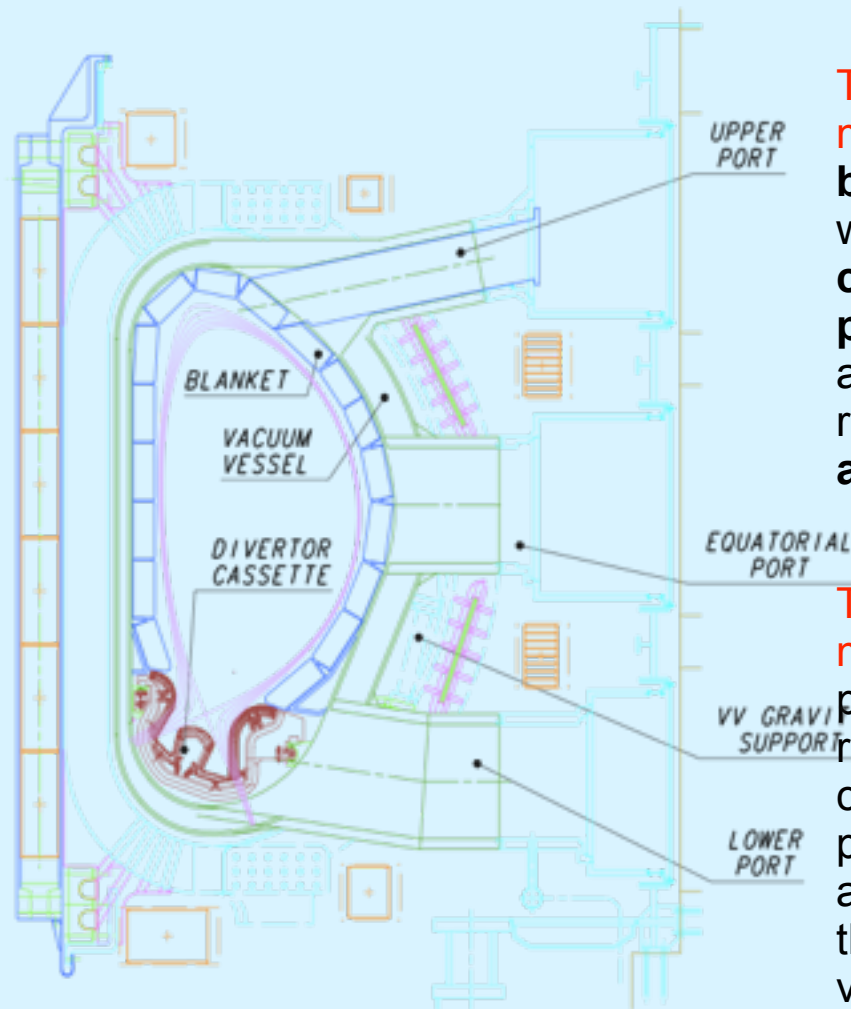

The double-walled vacuum vessel is lined by modular removable components, including blanket modules composed of a separate first wall mounted on a shield block, divertor cassettes, and diagnostics sensors, as well as port plugs such as the limiter, heating antennae, and test blanket modules. All these removable components are mechanically attached to the VV.

These vessel and internal components absorb most of the radiated heat from the plasma and protect the magnet coils from excessive nuclear radiation. This shielding is accomplished by a combination of steel and water, the latter providing the necessary removal of heat from absorbed neutrons. A tight fitting configuration of the VV to the plasma aids the passive plasma vertical stability, and ferromagnetic material in the VV located under the TF coils reduces the TF ripple and its associated particle losses.

# Vessel, Blanket & Divertor

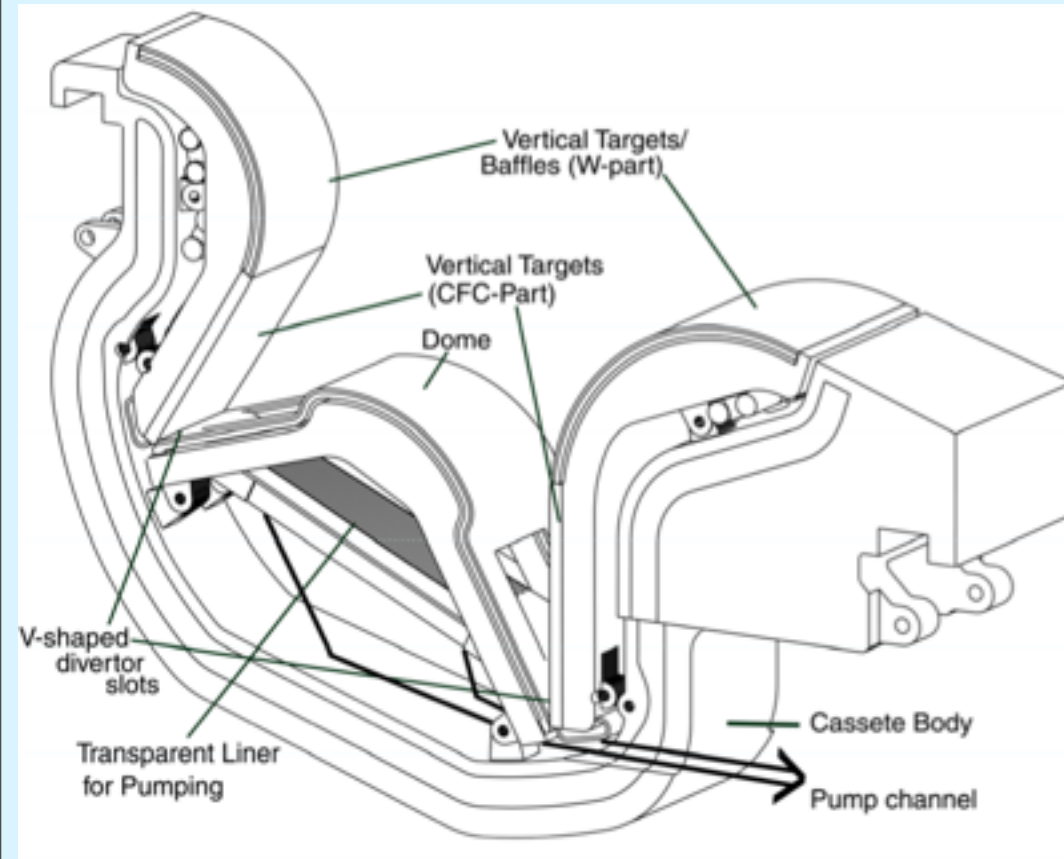

The divertor is made up of 54 cassettes. The target and divertor floor form a V which traps neutral particles protecting the target plates, without adversely affecting helium removal. The large opening between the inner and outer divertor balances heat loads in the inboard and outboard channels.

The design uses C at the vertical target strike points. W is the backup, and both materials have their advantages and disadvantages. C is best able to withstand large power density pulses (ELMs, disruptions), but gives rise to tritiated dust and T codeposited with C which has to be periodically removed. The best judgement of the relative merits can be made at the time of procurement.

# Additional Heating

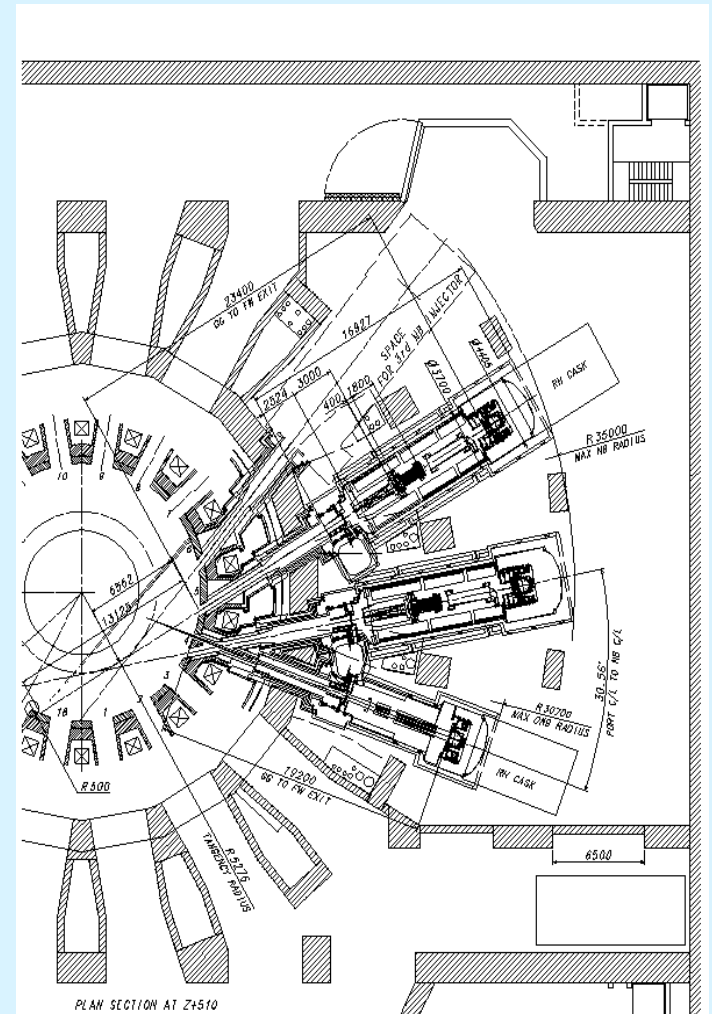
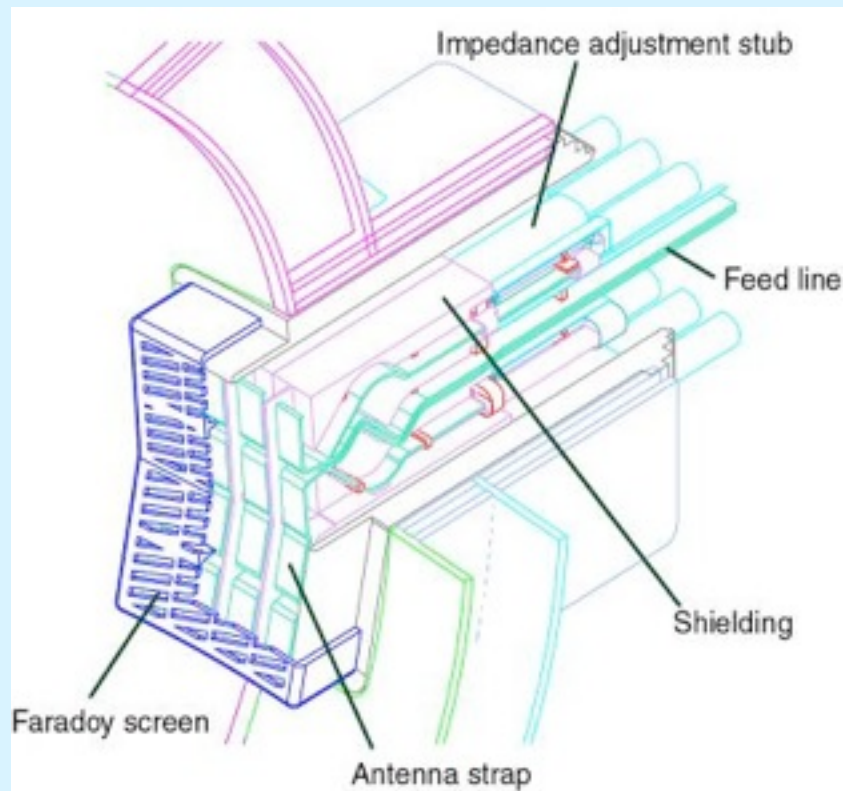

- 2 NBI beamlines (33MW), 1 ICRH antenna (20MW), 1 ECRH launcher (20 MW) and later either one LH launcher or additional ICRH or ECRH power are foreseen

# Remote Maintenance of in vessel components is performed by cask based tools

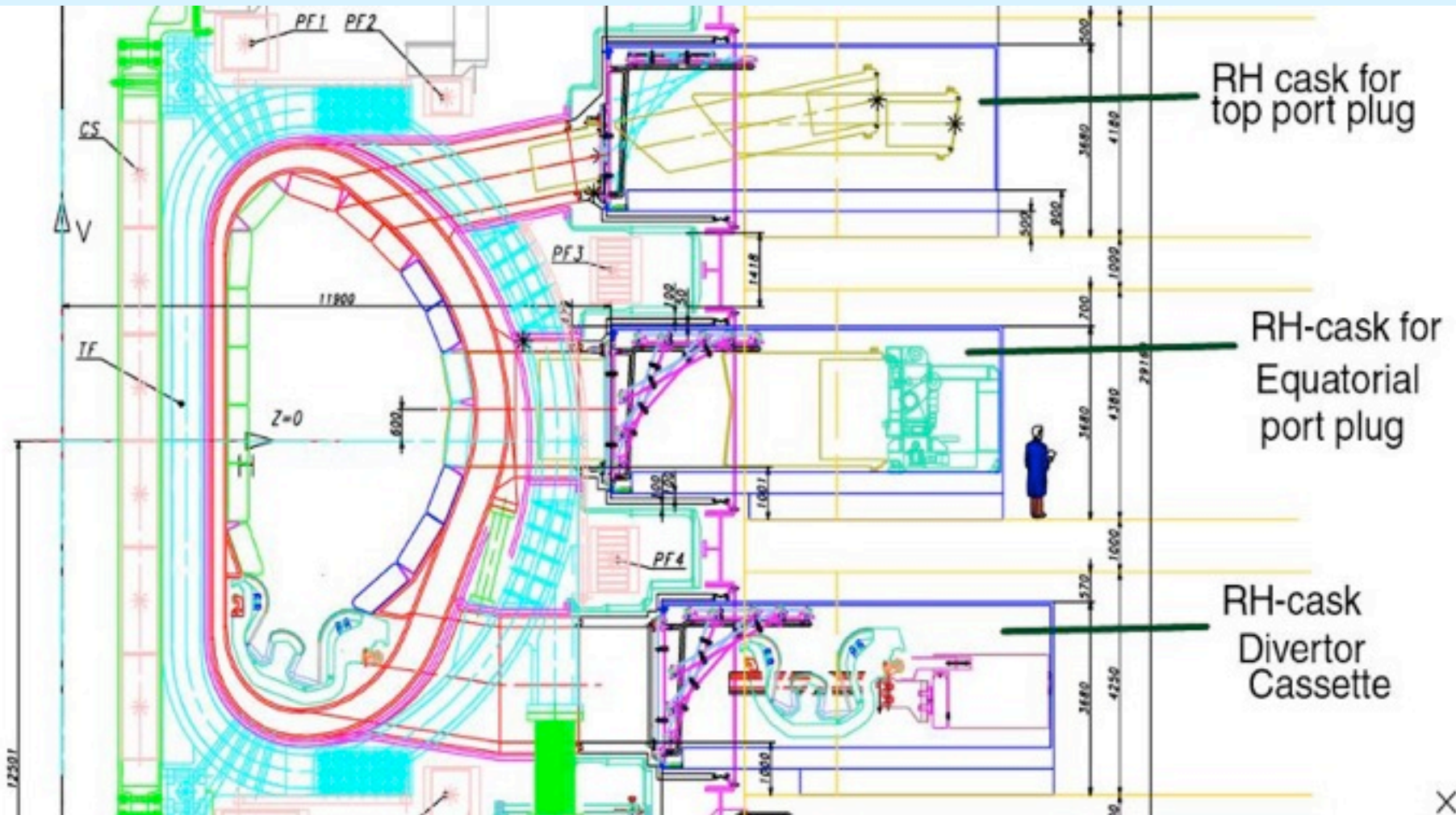

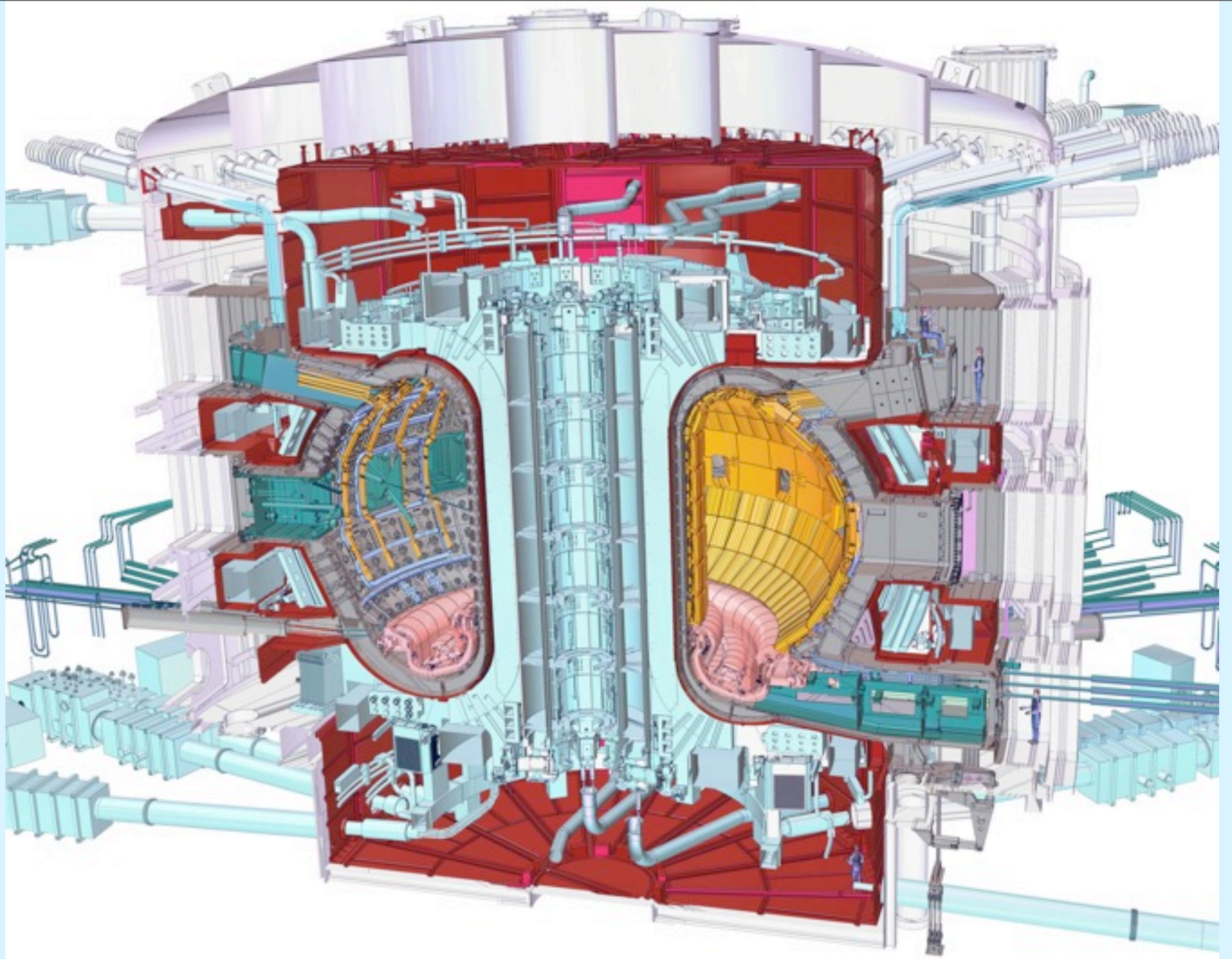



# Underpinning R&D for ITER

- The ITER design uses established design and manufacturing approaches and validates their application to ITER through technology R&D, **including fabrication and testing of full scale or scalable models** of key components, as well as generation of underlying design validation data.
- **Seven Large R&D Projects** were established for the basic machine:
  - central solenoid and toroidal field model coils
  - vacuum vessel sector, blanket module, and divertor cassette
  - blanket and divertor remote handling
- Other R&D concerned safety-related issues, and auxiliary systems - heating and current drive, fuelling and pumping, tritium processing, power supplies and diagnostics, etc.

# ITER Safety & Environmental Characteristics

- One of the main ITER goals is to **demonstrate the safety and environmental advantages of fusion:**
  - low fuel inventory, ease of burn termination, self-limiting power level
  - low power and energy densities, large heat transfer surfaces and heat sinks
  - confinement barriers anyway exist and need to be leak-tight for operation
- ***Environmental impact***
  - potential dose to most exposed member of public is < 1% background under normal operation
  - under worst accidents, dose to most exposed member of the public would be similar to background
  - even under hypothetical (i.e not accident sequence driven) internal events, **no technical need for public evacuation.**
- ***Waste***
  - about 30,000 t of material will be radioactive at shutdown. 24,000 t of this can be cleared (without reprocessing) for re-use within 100 years.
- ***Worker Safety***
  - assessment of all major system maintenance procedures demonstrates low occupational exposure, and this is being further refined as part of the project's ALARA policy.

# ITER Construction Valuation Method

- Construction broken into 85 procurement packages representative of actual contracts - half inside the 'pit', rest for peripheral equipment.
- Industry and large laboratories with relevant experience analysed manufacturing and estimated manpower, materials, tooling, etc. for given delivery schedule.
- Value estimates of each package consolidated by using a single set of labour rates and material costs .
- Since many items contributed "in kind", actual cost at home to each partner may not correspond to the project value, but partners have agreed collectively on the relative value of different packages, and therefore on each partner percentage share of the total construction cost.
- To eliminate currency/inflation fluctuations, all valuations made in 1989 US \$ (ITER Unit of Account, IUA ).

# Indicative system costing

Components/Systems	Indicative Cost (kIUA)	% of Total
Magnet Systems	880	27
Vac.Vessel, Blanket & Divertor	507	16
Tokamak Power Supplies	224	7
Diagnostics	215	6
Other Main Tokamak Systems	664	21
Heating Systems (73 MW total)	229	7
Buildings, Site Facilities. & BOP	503	16
<b>Total Direct Capital Costs</b>	<b>3222</b>	<b>100</b>
Management and support	<b>480</b>	
R&D during construction	<b>≈70</b>	
<b>Operation costs (average/year)</b>		
- permanent personnel	<b>60</b>	
- energy + fuel	<b>≈30 + 8</b>	
- maintenance/improvements	<b>≈90</b>	
<b>Decommissioning (without...)</b>	<b>335</b>	

# Construction Schedule

First plasma



## ITER Construction

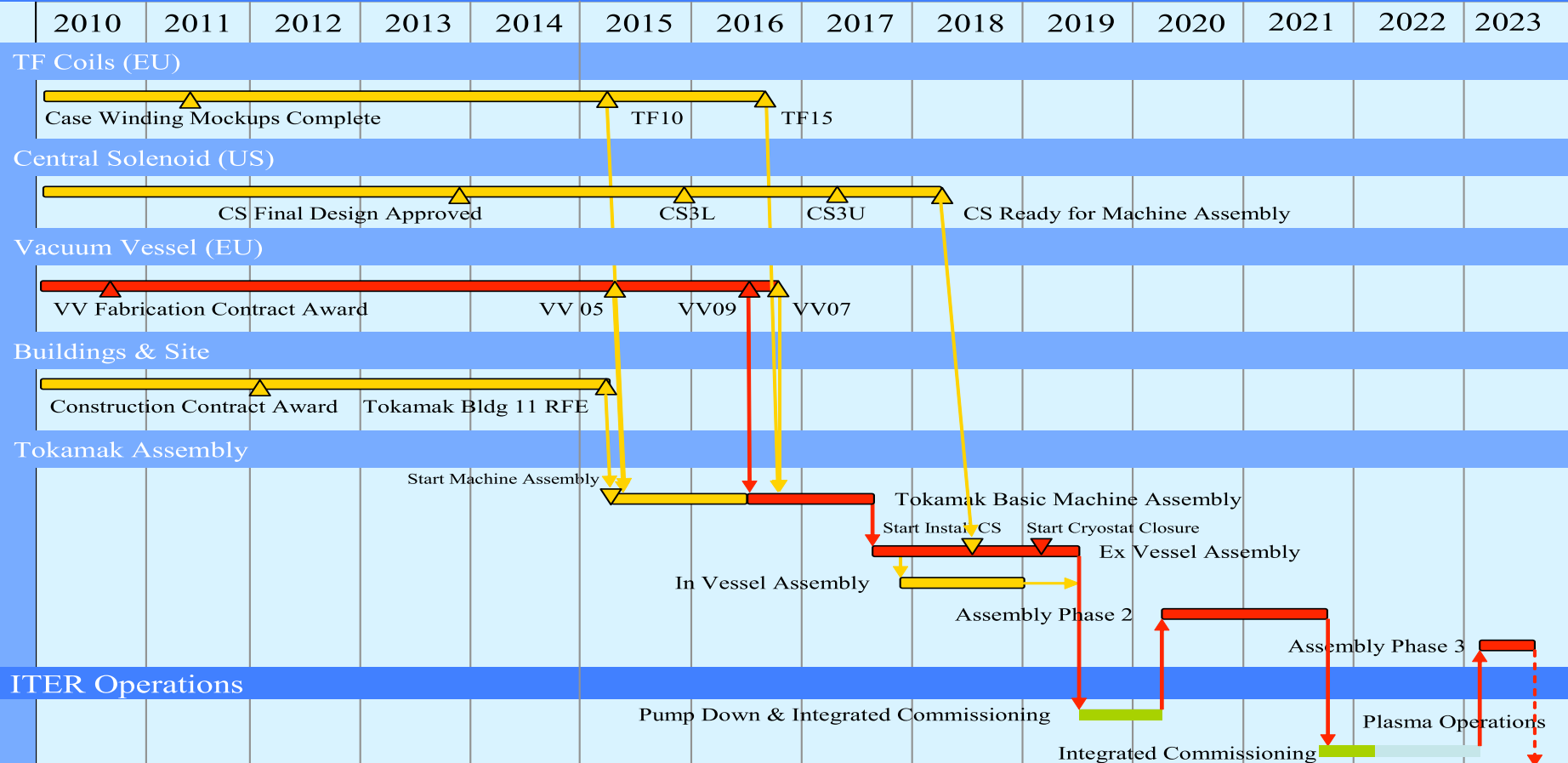

# Operation Schedule

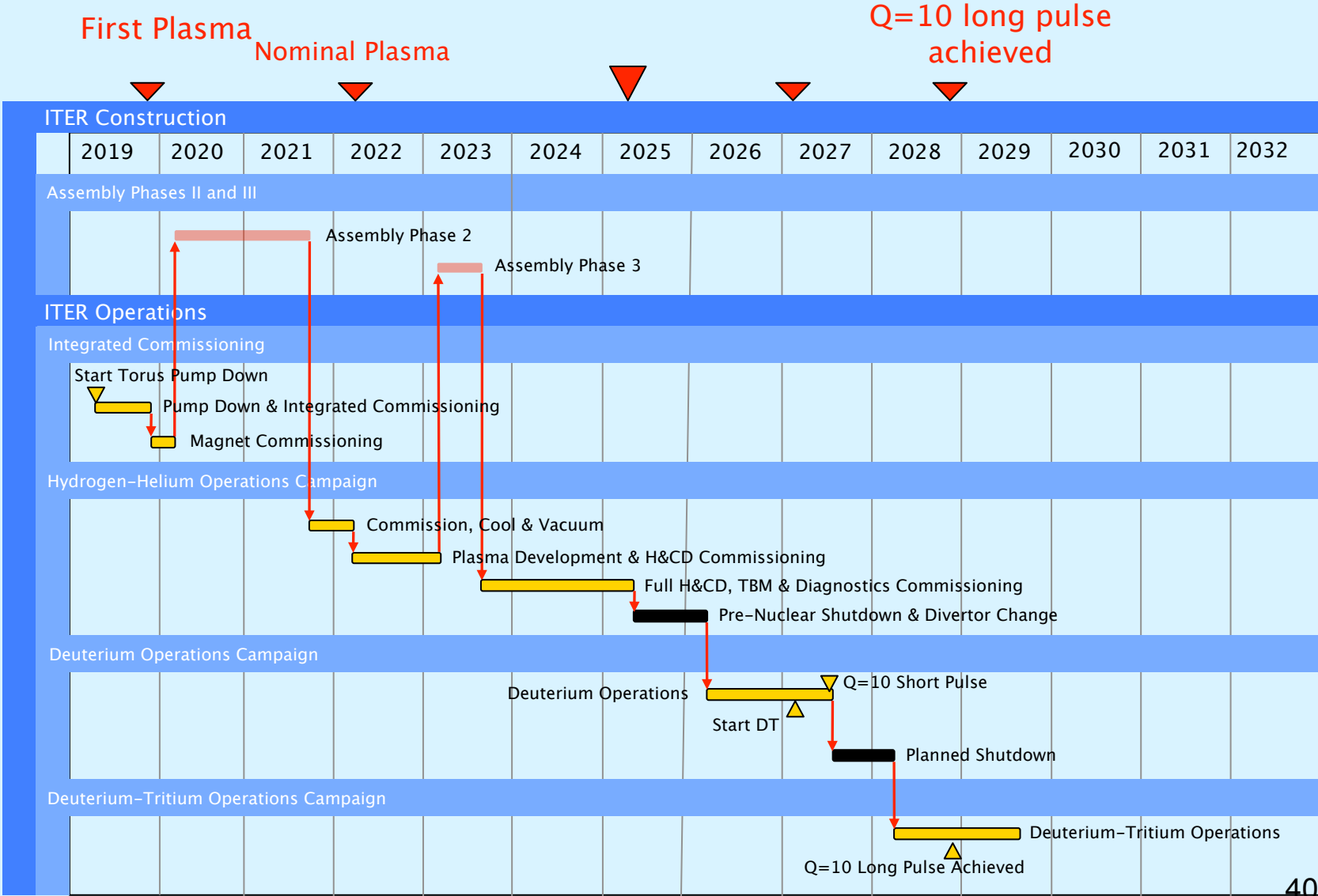

# Conclusions

- The need for **a burning plasma experiment ITER** at the centre of the fusion development strategy is undisputed.
- There is consensus that it will reach its objectives and “the world fusion programme is scientifically and technically ready to take the important ITER step”.
- The success of the EDA demonstrates feasibility and underlines the desirability of jointly implementing ITER in a broad-based international collaborative frame: it supports the Parties’ **declared policy to pursue the development of fusion through international collaboration**.
- Negotiations between 7 parties (EU, China, India, JA , Korea, RF, US) on an agreement for joint construction and operation of ITER started in 2001; competition between two possible sites, in Japan and Europe has led to delays, resolved in favour of the European site at Cadarache (France). The International Agreement was signed in Nov 2006.
- **Construction has started on site**; the International Team is fully operational, Domestic have been established in each Party and **first orders issued**.

**Therefore, it is safe to say that Nuclear Fusion is alive and well !  
The potential for energy generation is real.**





# CS Model Coil



- Largest, high field, pulsed superconducting magnet in the world. Similar in size and characteristics to one of the modules of the ITER CS.
- Uses ~ 25 t of strand. The inner module (US), the outer module (JA), and the insert coil (JA) were assembled at JAERI.
- Maximum field of 13 T with a cable current of 46 kA has been successfully achieved. Stored energy of 640 MJ at 13 T was safely dumped with a time constant as short as 6 s (vs. 11 s in the ITER CS).
- Picture shows the outer module being placed inside the inner module inside the vacuum chamber.

# R&D - TF Model Coil



Conductor after heat treatment, opened out by 'unspringing' to give space to wrap with insulation without damaging the superconductor. The insulation has been applied to the lower turns. (Ansaldo Energia)

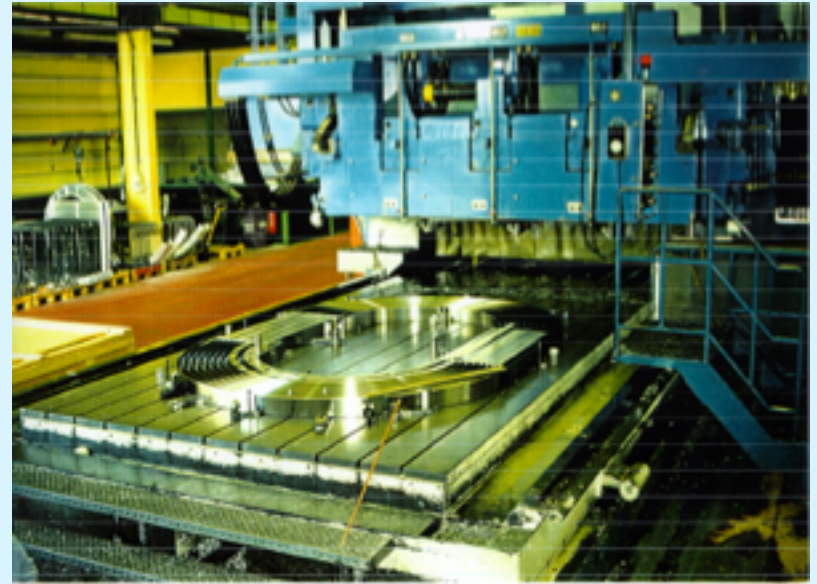

**Machining of the radial plate which reinforces the conductor. The conductor is fitted into grooves in this plate. (Mecachrome/Nöll)**

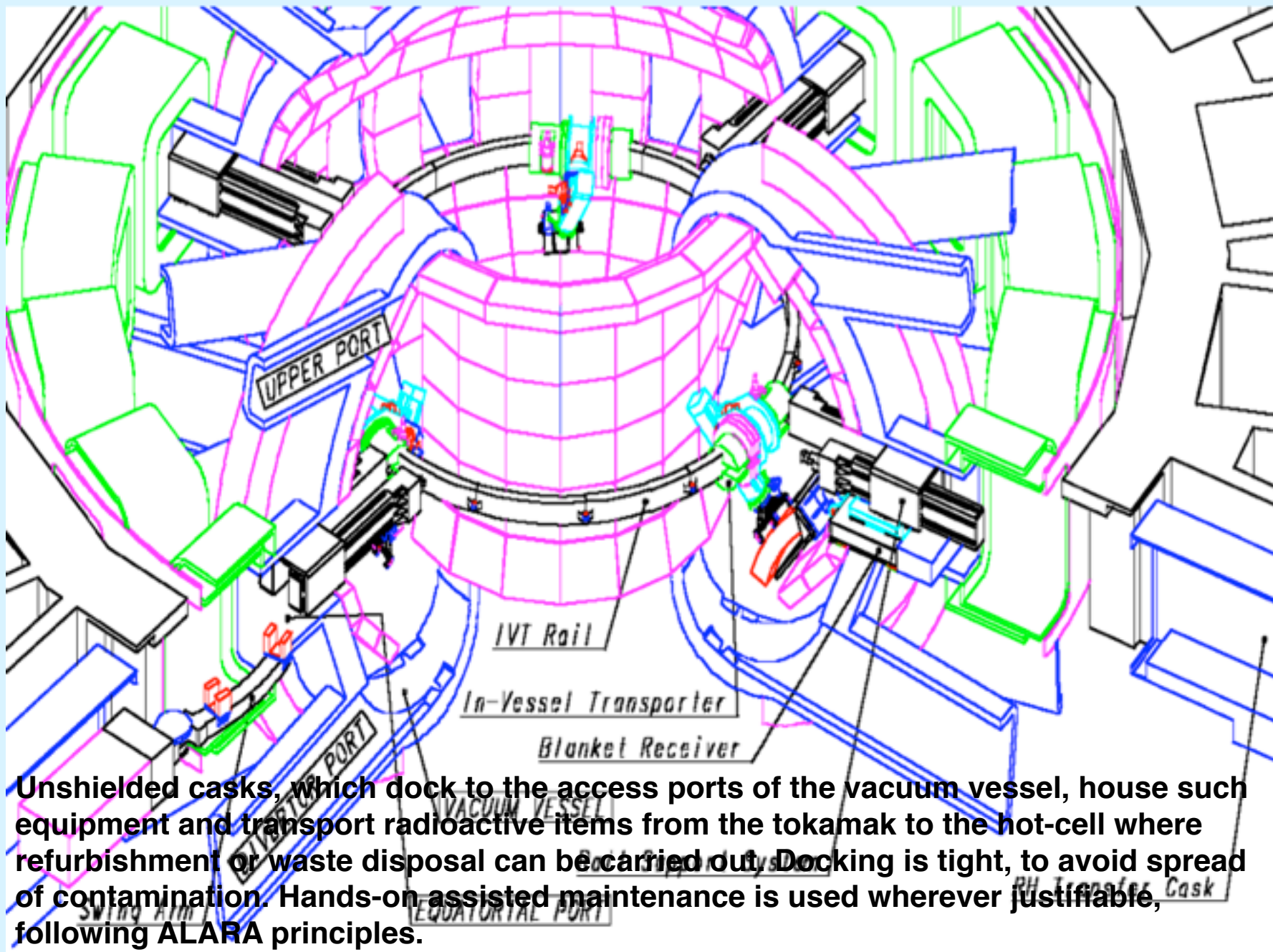

# In-vessel Remote Handling (2)

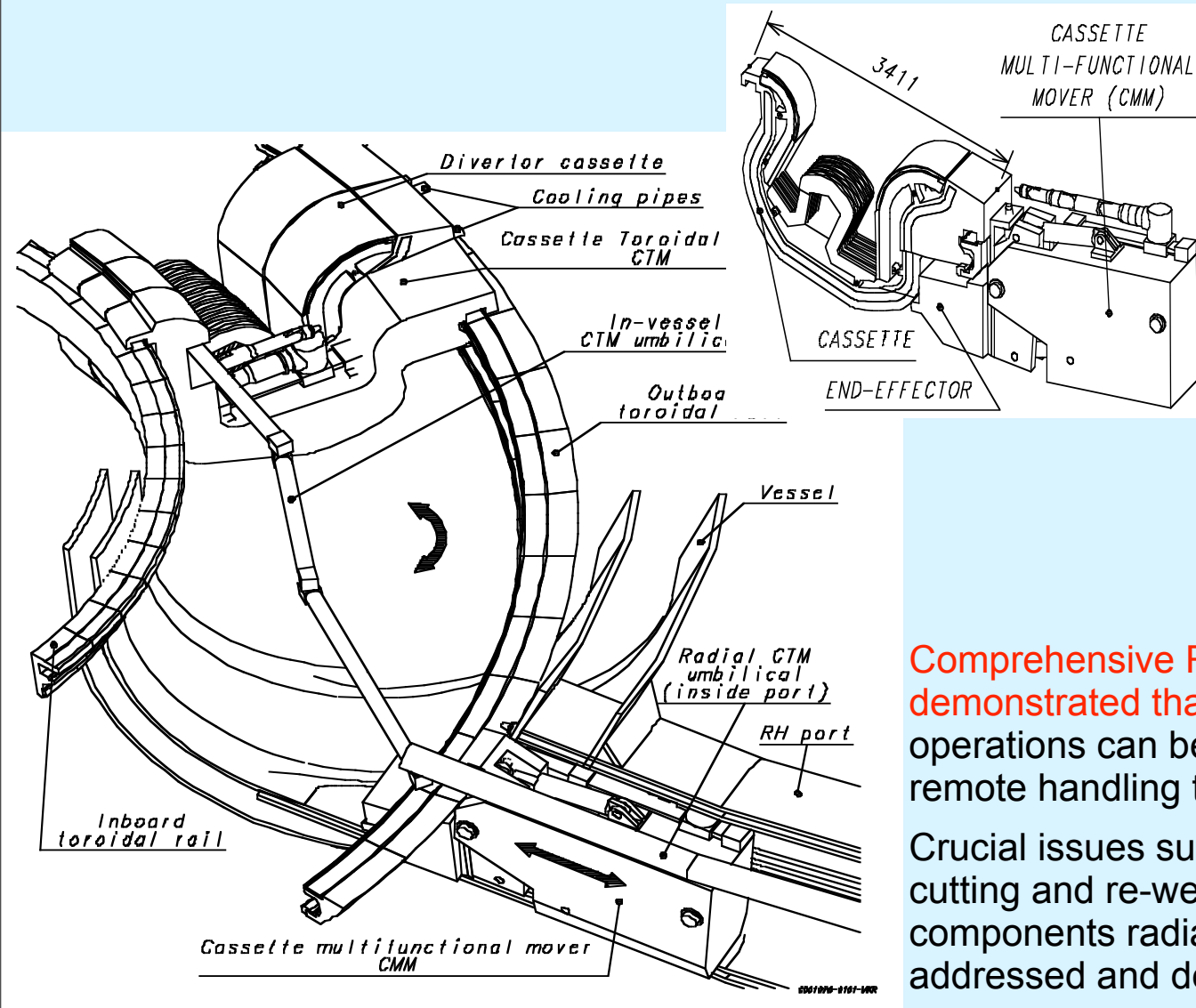

Multifunction manipulators are used for diverter cassette removal and to handle vacuum vessel port plugs. A toroidal mover slides the diverter cassettes along rails into their final position.

**Comprehensive R&D has successfully demonstrated that key maintenance operations can be achieved using common remote handling technology.**

Crucial issues such as vacuum vessel remote cutting and re-welding, viewing, materials and components radiation hardness have been addressed and demonstrated.

# Design Feasibility - Maintenance

**Vehicle Manipulator System  
for Blanket Maintenance**  
Payload~4 ton, Arm length~6m

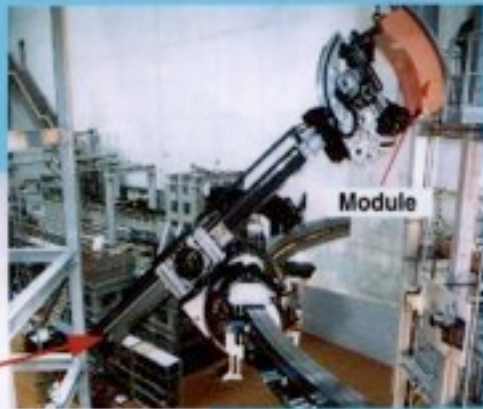

Module

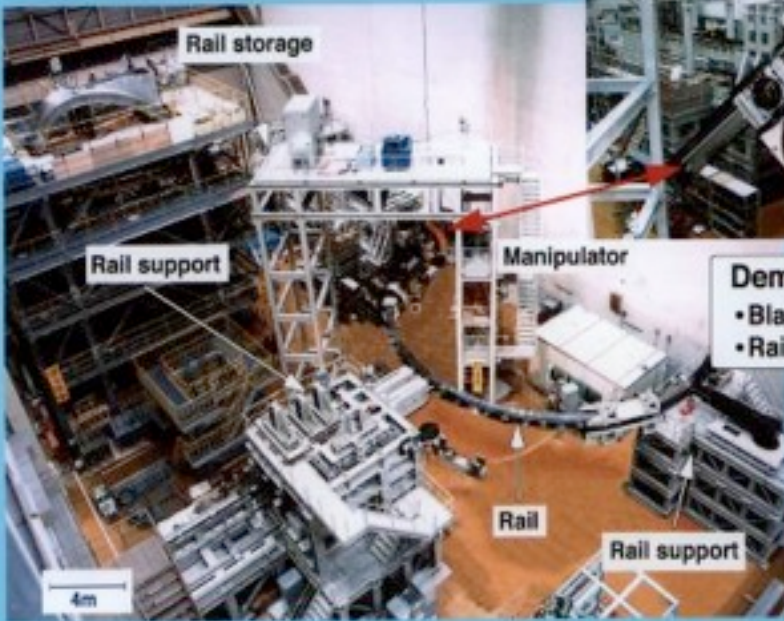

Rail storage

Rail support

Manipulator

Rail

Rail support

**Demonstration of**  
• Blanket module handling  
• Rail deployment

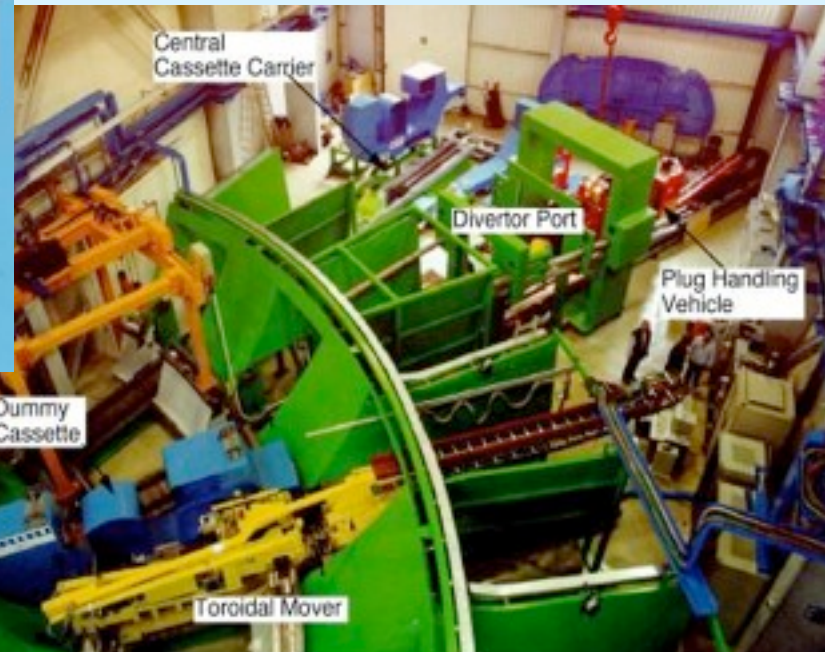

Central  
Cassette Carrier

Divertor Port

Plug Handling  
Vehicle

Dummy  
Cassette

Toroidal Mover